

**AUDIO SPECIAL ISSUE: THREE GREAT PROJECTS!**

OCTOBER 1995

# Electronics Combined with Radio **Electronics®**

# NOW®

## HIGH-POWER HI-FI AUDIO AMPLIFIER

Build this FET-based amplifier for home hi-fi or professional sound-reinforcement applications

## A Subwoofer For Your Car

Make your car stereo system the envy of your neighborhood!

## Powered Subwoofer

Bring your stereo up to date and bring life to your home theater!

## Seeing The Unseen

The life, times, and photography of Harold Edgerton



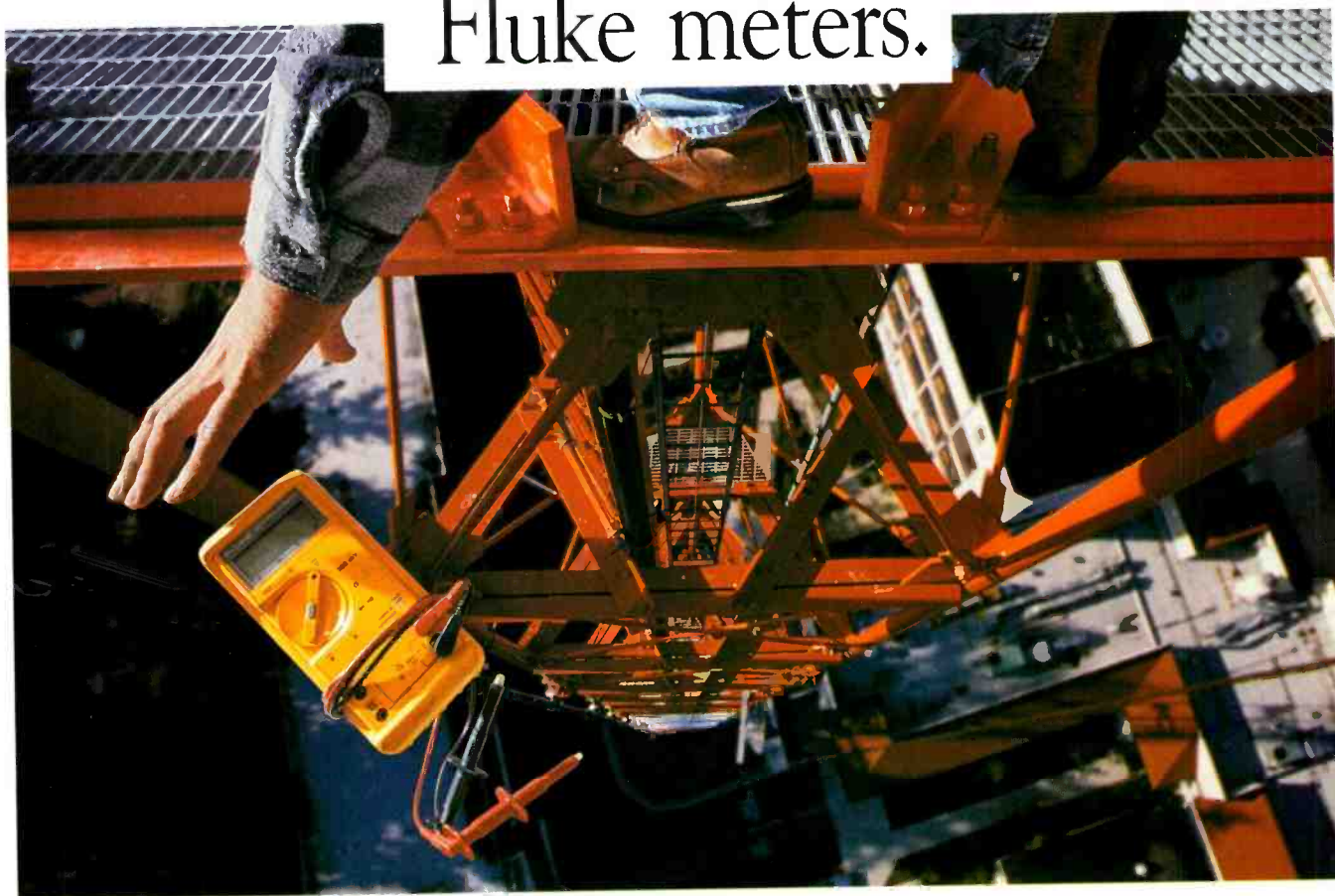
\$3.50 U.S.  
\$3.95 CAN.

#BXNBQWF\*\*\*\*\* 5-DIGIT 95067  
 #BRKPOB67397 5#303178 OAP34  
 @@@@@@  
 JUN 97  
 CHRIS BARKER 10EN  
 \_\_\_\_\_

A GERNSBACK PUBLICATION

www.americanradiohistory.com

# A crash course in why you can *always* count on Fluke meters.



**Professionals know Fluke never lets you down.** Every day, you're asked to rise to new challenges. You need a test tool as tough as your job. True story: a tech working atop a 170-foot tower accidentally knocks his Fluke 23 meter and an industrial-grade screwdriver over the edge. Straight down they fall, crashing to the asphalt below. He goes down. His screwdriver's handle is shattered. Expecting the worst, he gingerly picks up his Fluke meter and smiles. All that's broken is a fuse. He snaps in



another, goes right back up and continues testing with the *same* Fluke 23. No harm to the meter — or the pocketbook. Unbelievable? Not when you consider every rotary knob, keypad, and switch on every Fluke meter must pass strict testing for drops, intense heat or cold, electrical overloads, and years of harsh wear and tear. What's more, Fluke meters are built in an

ISO 9001 certified factory. So you know you can always meet your quality goals. People depend on you, so depend on Fluke. See your Fluke distributor today, or call 1-800-59-FLUKE for a catalog and a direct connection to a distributor near you and ask for a catalog.

CIRCLE 121 ON FREE INFORMATION CARD

For technical or application support call 1-800-44-FLUKE.  
© 1994 Fluke Corporation, P.O. Box 9090, M/S 250E, Everett, WA,  
USA 98206-9090. Canada (905) 890-7600.  
Europe (31 40) 644200. Other Countries (206) 356-5500.

Send us your "Fluke survival story"  
[www.americatechnology.com](http://www.americatechnology.com)

Serious Tools for Serious Work

**FLUKE**®

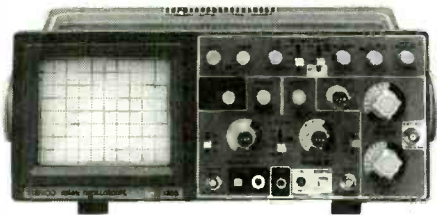
**FREE PROBES  
WITH ALL  
SCOPES**

**ELENCO ♦ HITACHI ♦ B+K  
SCOPES  
AT GUARANTEED LOWEST PRICES**

**WRITE FOR  
FREE  
CATALOG**

**QUALITY - ELENCO OSCILLOSCOPES**

**2- YEAR WARRANTY**



**60MHz**

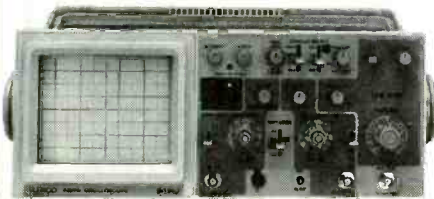
**S-1360 \$775**

Delayed Sweep

**S-1365 \$849**

Cursor Readout

- ♦ Voltage, Time
- ♦ Frequency differences displayed on CRT



**40MHz**

**S-1340 \$495**

2- Channel

**S-1345 \$575**

Delayed Sweep

- ♦ Beam Find
- ♦ Component Tester



**25MHz**

**S-1325 \$349**

2- Channel

**S-1330 \$449**

Delayed Sweep

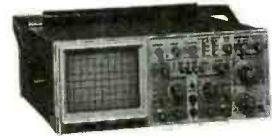
- ♦ Beam Find
- ♦ Component Tester

*Dependable Equipment at Affordable Prices*

**B+K 20MHz**

2 Channel

**Model 2120 \$389.00**



Delayed Sweep

**Model 2125 \$539.95**

**40MHz DUAL -TRACE**

**Model 1541B**

**\$749.95**

- 1mV/div sensitivity
- Video sync separators
- Z axis input
- Single sweep
- V mode-displays 2 signals unrelated in frequency

**60MHz DUAL-TRACE**

**Model 2160**

**\$949.95**

- 1mV/div sensitivity
- Sweep to 5ns/div
- Dual time base
- Signal delay line
- Component tester
- V mode-displays 2 signals unrelated in frequency

**100MHz THREE-TRACE**

**Model 2190**

**\$1,379.95**

- 1mV/div sensitivity
- Sweeps to 2ns/div
- Dual time base
- Signal delay line
- 19kV accelerating voltage
- Calibrated delay time multiplier

**20MHz ANALOG with  
DIGITAL STORAGE**

**Model 2522A**

**\$869.95**

- 20MHz analog bandwidth
- 20MS/s sampling rate
- 2k memory per channel
- 20MHz equivalent time sampling

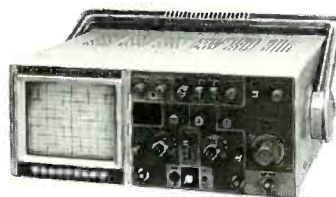
**HITACHI POPULAR SERIES**

V-212 - 20MHz, 2 Channel	\$425.00
V-222 - 20MHz, DC Offset	\$695.00
V-422 - 40MHz, Dual Trace	\$849.00
V-522 - 50MHz, Dual Trace	\$975.00
V-523 - 50MHz, Delayed Sweep	\$995.00
V-525 - 50MHz, w/ Cursor	\$1,069.00

**HITACHI COMPACT SERIES SCOPES**

V-660 - 60MHz, Dual Trace	\$1,375.00
V-665A - 60MHz, DT, w/cursor	\$1,449.00
V-1060 - 100MHz, Dual Trace	\$1,549.00
V-1065A - 100MHz, DT, w/cursor	\$1,695.00
V-1085 - 100MHz, QT, w/cursor	\$2,125.00
VC-6045A - 100MHz, Digital Stor	CALL
VC-6025A - 50MHz, Digital Stor	CALL

**Elenco DS-203 20MHz, 10MS/s  
Digital Storage Oscilloscope**



**\$749**

2K Word Per Channel • Plotter Output  
8 Bit Vert. Resolution • 2048 Pts Hor.  
Resolution • Much More.....

**FLUKE SCOPEMETERS**

A handheld instrument that combines a 50MHz, 25MS/s dual channel digital storage oscilloscope with feature-packed 3000 count digital multimeter.



**Model 93 - \$1,225**

**Model 95 - \$1,549**

**Model 97 - \$1,795**

- Autoset, automatically sets voltage, time & trigger
- Multimeter display, 3-2/3 digits (>3000 counts)
- True RMS volts; AC or AC+DC up to 600V

**C&S SALES INC.**

1245 ROSEWOOD, DEERFIELD, IL 60015  
FAX: 708-520-0085 (708) 541-0710

**CALL TOLL FREE**

**1-800-292-7711**

**1-800-445-3201 (Can)**



**15 DAY MONEY BACK GUARANTEE  
FULL FACTORY WARRANTY  
ALL PRODUCTS ARE FACTORY NEW**

PRICES SUBJECT TO CHANGE WITHOUT NOTICE

CIRCLE 109 ON FREE INFORMATION CARD

# CONTENTS

OCTOBER 1995

**ON THE COVER****33 HI-POWER HI FI AUDIO AMPLIFIER**

A powerful stereo amplifier is at the heart of every serious home entertainment system. And while manufacturers' specifications seem to indicate that very powerful amplifiers can be had for very little money, the fact is that truly powerful amplifiers that don't clip when they're cranking are still quite expensive — unless you build one yourself. We are presenting a powerful stereo amplifier (300 watts per channel into eight ohms!) that you can build yourself. This lightweight, high-performance stereo amplifier can be built for less than \$450 in parts, but it performs better than high-end amplifiers that cost up to ten times that amount. Turn to page 33 for details.

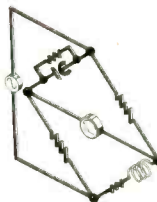
— Reinhard Metz and Myzil Boyce

**TECHNOLOGY****35 LOW-COST SOFTWARE FOR ELECTRONICS**

Part 2 in our coverage of low-cost schematic capture and drawing software  
— TJ Byers

**43 L-C BRIDGES**

Learn about popular capacitance and inductance bridges.  
— Ray Marston

**45 SEEING THE UNSEEN**

The inventor of stroboscopes became an artist by accident.

— Philip Conday



As a service to readers, ELECTRONICS NOW publishes available plans or information relating to newsworthy products, techniques and scientific and technological developments. Because of possible variances in the quality and condition of materials and workmanship used by readers, ELECTRONICS NOW disclaims any responsibility for the safe and proper functioning of reader-built projects based upon or from plans or information published in this magazine.

Since some of the equipment and circuitry in ELECTRONICS NOW may relate to or be covered by U.S. patents, ELECTRONICS NOW disclaims any liability for the infringement of such patents by the making, using, or selling of any such equipment or circuitry, and suggests that anyone interested in such projects consult a patent attorney.

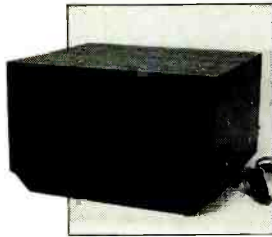
ELECTRONICS NOW, (ISSN 1067-9294) October 1995. Published monthly by Gernsback Publications, Inc., 500 Br-County Boulevard, Farmingdale, NY 11735-3931. Second-Class Postage paid at Farmingdale, NY and additional mailing offices. Canada Post IPM Agreement No. 334103, authorized at Mississauga, Canada. One-year subscription rate U.S.A. and possessions \$19.97, Canada \$27.79 (includes G.S.T. Canadian Goods and Services Tax, Registration No. R125166280), all other countries \$28.97. All subscription orders payable in U.S.A. funds only, via international postal money order or check drawn on a U.S.A. bank. Single copies \$3.50. © 1995 by Gernsback Publications, Inc. All rights reserved. Printed in U.S.A.

POSTMASTER: Please send address changes to ELECTRONICS NOW, Subscription Dept., Box 55115, Boulder, CO 80321-5115.

A stamped self-address envelope must accompany all submitted manuscripts and/or artwork or photographs if their return is desired should they be rejected. We disclaim any responsibility for the loss or damage of manuscripts and/or artwork or photographs while in our possession or otherwise.

**BUILD THIS**

**37 POWERED SUBWOOFER**  
Add dramatic bass to a home-entertainment system.  
— *Rodrick Seely*

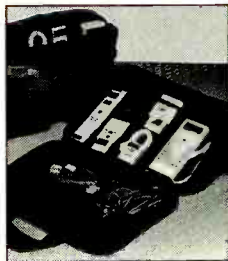


**41 BUILD THIS SUBWOOFER FOR YOUR CAR**  
Improve the bass response in an automotive sound system.  
— *Mark Rumreich*

**DEPARTMENTS**

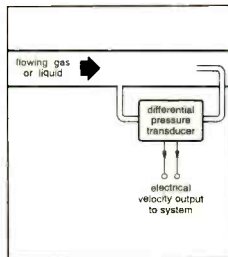
**6 VIDEO NEWS**  
What's new in this fast-changing field. — *David Lachenbruch*

**16 EQUIPMENT REPORTS**  
Fieldpiece HS24K15 Stick Meter Fieldpack.



**47 HARDWARE HACKER**  
Understanding Pitot tubes, and more. — *Don Lancaster*

**53 AUDIO UPDATE**  
High-Definition-Compatible Digital Processing.  
— *Larry Klein*



**55 DRAWING BOARD**  
A general-purpose controller circuit. — *Robert Grossblatt*

**61 COMPUTER CONNECTIONS**  
Windows 95 update. — *Jeff Holtzman*

**AND MORE**

**4 WHAT'S NEWS**

**8 Q&A**

**14 LETTERS**

**18 NEW PRODUCTS**

**26 NEW LITERATURE**

**94 BUYER'S MART**

**98 ADVERTISING SALES OFFICES**

**98 ADVERTISING INDEX**

**Electronics NOW®**

Hugo Gernsback (1884-1967) founder

**LARRY STECKLER, EHF, CET,**  
Editor-in-chief and publisher

**EDITORIAL DEPARTMENT**

**BRIAN C. FENTON**, editor  
**MARC SPIWAK**, associate editor  
**NEIL SCLATER**, associate editor  
**TERI SCADUTO**, assistant editor  
**JEFFREY K. HOLTZMAN**  
computer editor  
**ROBERT GROSSBLATT**, circuits editor  
**LARRY KLEIN**, audio editor  
**DAVID LACHENBRUCH**  
contributing editor  
**DON LANCASTER**  
contributing editor  
**MICHAEL A. COVINGTON, N4TMI**  
contributing editor  
**EVELYN ROSE**, editorial assistant

**ART DEPARTMENT**

**ANDRE DUZANT**, art director  
**RUSSELL C. TRUELSON**, illustrator

**PRODUCTION DEPARTMENT**

**RUBY M. YEE**, production director  
**KAREN S. BROWN**  
advertising production  
**KATHRYN R. CAMPBELL**  
production assistant  
**KEN COREN**  
desk top production

**CIRCULATION DEPARTMENT**

**JACQUELINE P. CHEESEBORO**  
circulation director  
**THERESA LOMBARDO**  
circulation assistant

**REPRINT DEPARTMENT**

**MICHELE TORRILLO**  
reprint bookstore

Typography by Mates Graphics  
Cover design by David Loewy

**Electronics Now** is indexed in *Applied Science & Technology Index*, and *Readers Guide to Periodical Literature*, *Academic Abstracts*, and *Magazine Article Summaries*.

Microfilm & Microfiche editions are available. Contact circulation department for details.

**Advertising Sales Offices listed on page 98.**

Electronics Now Executive and Administrative Offices

**1-516-293-3000.**

Subscriber Customer Service:

**1-800-288-0652.**

Order Entry for New Subscribers:

**1-800-999-7139.**



Audit Bureau  
of Circulations  
Member



# WHAT'S NEWS

A REVIEW OF THE LATEST HAPPENINGS IN ELECTRONICS

## Safely spotting IC defects

A new, nondestructive technique for finding open conductors in integrated circuits with low-energy voltage has been developed by researchers at Sandia National Laboratories, Albuquerque, N.M.. The technique, called LECIVA (for low-energy charge-induced voltage alterations), locates microscopic

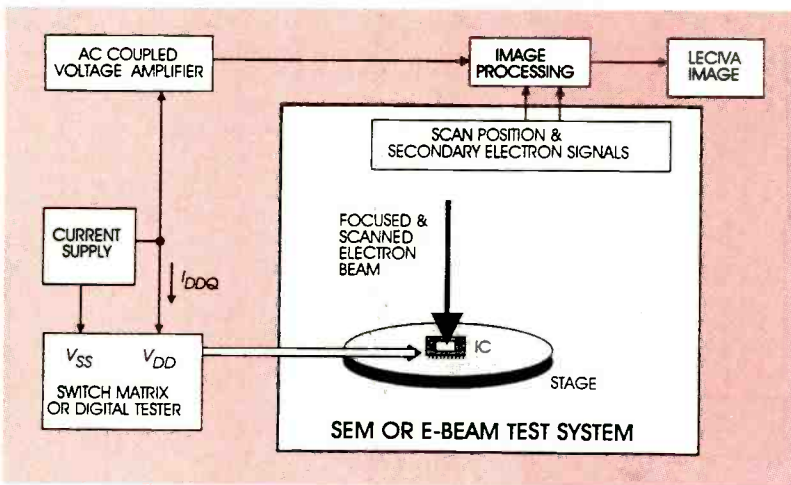
As an electron beam is scanned over the device's surface, the voltage fluctuation of a constant-current power supply produces images that are detectable with the SEM. The brightness at a particular spot on the chip is proportional to the voltage required to keep the current constant.

LECIVA simplifies the process of checking for IC defects by removing the risk of damaging the chip with excess radiation. Another

California, New York, and Massachusetts have decreed that by 1998, 2% of the cars sold in those states will be electric powered.

However, the inability of Detroit to build an attractive electric car has led Gov. William Weld of Massachusetts to relax the enforcement of its mandate. Weld said his state will not try to enforce its requirement until two years after someone, somewhere, introduces an acceptable vehicle.

Proponents of the electric car are now discussing the possibility of a "hybrid" vehicle with a small gasoline engine that would recharge the batteries because recharging is a significant problem that must be overcome. This raises the question of whether it is possible to build a small auxiliary gasoline-powered engine for charging purposes that will not, itself, pollute the air.



A LOW-ENERGY CHARGE-INDUCED VOLTAGE ALTERATION imaging system from Sandia Laboratories locates defects on ICs without damaging them.

cracks in IC substrates that break the electrical connections. LECIVA is seen as a method for improving the reliability of ICs, especially as linewidths have become smaller making it more difficult to detect and localize open conductors.

LECIVA is an improved imaging technique based on charge-induced voltage alterations. A scanning electron microscope (SEM) injects a small electric charge at a precise location on an interconnection. If there is an open conductor nearby, a voltage change will occur at the defect location.

advantage to LECIVA is that the low energy level allows it to be performed with commercial electron-beam test systems as well as scanning electron microscopes.

## Rough road for electric cars

Hopes for the appearance of an electric cars that would appeal to consumers have yet to be realized despite mandates from three states and the setting of quotas for them.

## TV violence-control chip

In July President Clinton called the Nation's attention to the V-chip ("V" stands for violence) that would permit parents to block offensive television programs transmitted with a signal identifying them as containing violent scenes or other programming inappropriate for children.

Semiconductor manufacturers say the technology for making the device is readily available and similar to that for "closed-captioning." Television manufacturers add that the ICs could be installed in television sets for as little as \$5. Consequently the possible stumbling block is neither technology nor price to produce such an integrated cir-

*Continued on page 82*

# 5 BOOKS FOR ONLY \$4.95

WHEN YOU JOIN THE

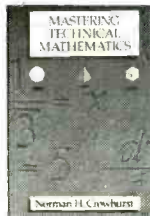
## Electronics Book Club®

VALUES TO \$158.30

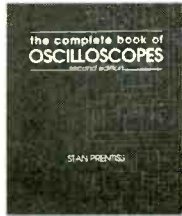
The leading source of information for electronics hobbyists for over 30 years!



2790P \$17.95



3438P \$24.95



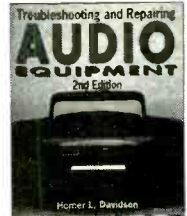
3825P \$17.95



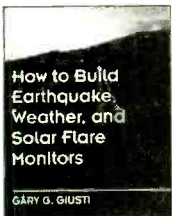
2613P \$19.95



3765P \$19.95



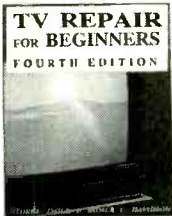
4112H \$32.95 Hardcover



0252092 \$19.95



4179H \$28.95 Hardcover



3627P \$19.95

0673764-XX \$54.95 Counts as 2/Hardcover

**3795P \$19.95**

ALDHO & VIDEO CASSETTE PLAYERS & RECORDERS

**BENCHTOP ELECTRONICS Reference Manual**

0376581 \$39.50

McGraw-Hill ELECTRONIC TROUBLESHOOTING HANDBOOK JOHN D. LENK

3669P \$19.95

3711P \$19.95

HOME VCR REPAIR ILLUSTRATED

4227P \$15.95

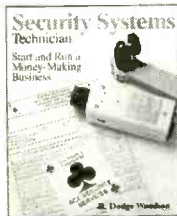
3258P \$19.95

1367P \$29.95

THE GIANT BOOK OF ELECTRONICS PROJECTS

3288P \$19.95

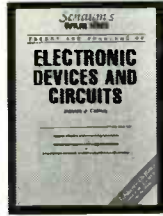
Troubleshooting & Repairing Electronic Circuits



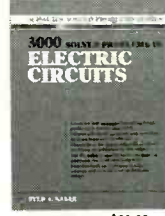
0717753 \$19.95



3279P \$26.95



0102740 \$12.95



0459363-XX \$21.95 Counts as 2



0487375 \$24.95

### As a member of the ELECTRONICS BOOK CLUB . . .

you'll enjoy receiving Club bulletins every 3-4 weeks containing exciting offers on the latest books in the field at savings of up to 50% off the regular publishers' prices. If you want the Main Selection, do nothing and it will be shipped automatically. If you want another book, or no book at all, simply return the reply form to us by the date specified. You'll have at least 10 days to decide. If you ever receive a book you don't want due to late delivery of the bulletin, you can return it at our expense. Your only obligation is to purchase 3 more books during the next 12 months, after which you may cancel your membership at any time. And you'll be eligible for FREE BOOKS through our Bonus Book Program.

A shipping/handling charge and sales tax will be added to all orders. All books are softcover unless otherwise noted. If you select a book that counts as 2 choices, write the book number in one box and XX in the next. (Publishers' Prices Shown) ©1995 EBC

If coupon is missing, write to:  
Electronics Book Club,  
A Division of McGraw-Hill, Inc.,  
P.O. Box 549, Blacklick, OH 43004-9918

## Electronics Book Club®

A Division of McGraw-Hill, Inc., P.O. Box 549, Blacklick, OH 43004-9918

YES! Please send me the books listed below, billing me just \$4.95 plus shipping/handling & tax. Enroll me as a member of the **Electronics Book Club** according to the terms outlined in this ad. If not satisfied, I may return the books within 10 days without obligation and have my membership cancelled.

--	--	--	--

If you select a book that counts as 2 choices, write the book number in one box and XX in the next.

Name \_\_\_\_\_

Address/Apt. # \_\_\_\_\_

City/State \_\_\_\_\_

Zip \_\_\_\_\_ Phone \_\_\_\_\_

Valid for new members only, subject to acceptance by EBC. Canada must remit in U.S. funds drawn on U.S. banks. Applicants outside the U.S. and Canada will receive special ordering instructions. Publishers' prices shown. A shipping/handling charge & sales tax will be added to all orders. RPIE1095

PHONE: 1-614-759-3666 (8:30 a.m. to 5:00 p.m. EST Monday-Friday) • FAX: 1-614-759-3749 (24 hours a day, 7 days a week)



# VIDEO NEWS

WHAT'S NEW IN THE FAST-CHANGING VIDEO INDUSTRY

BY DAVID LACHENBRUCH

## And then there were none

U.S.-owned TV manufacturers, that is. The announcement that control of Zenith Electronics is being sold to Korea's LG Electronics (formerly Goldstar) brought forth an outpouring of nostalgia as the last of its breed became wedded to a global company—following the earlier sale of RCA and GE consumer electronics brands to Thomson of France and the sale of Magnavox to Philips of the Netherlands in earlier years.

From the technological standpoint, at least, the latest wedding is good news. After 10 consecutive years of losses, cash-short Zenith has lacked the funds to capitalize on the skill of its engineers. As a major contributor to the Grand Alliance digital HDTV system, Zenith stands to benefit in the future from the wealth and the technical acumen of its new Korean parent. In recent years, Zenith has had to shelve development work on the flat tension mask (FTM) picture tube because of costs. However, in 1991, when Zenith sold five percent of its stock to LGE, it made a deal to share knowhow on the FTM tube with the Korean company, which has since been working quietly to bring down the cost of this tube. FTM has a completely flat plate glass faceplate, virtually no reflections and the ability to reproduce a picture that resembles a 35-mm slide. Now LGE plans—along with Zenith—to accelerate work on FTM, which initially will be offered as a professional monitor, later as a TV tube if costs are sufficiently reduced.

## Matsushita's 'PF' tube

The Zenith-Goldstar FTM tube has a competitor. Just one week before the two companies announced the takeover deal, Matsushita Electric of Japan, the parent of Panasonic, announced that it would begin pilot production of the "Pure Flat" or "PF" tube. Like Zenith's FTM, the PF tube uses a shadow mask mounted under tension and a completely flat faceplate, providing what Matsushita calls a "paper-like" image. The first PF tube applications will be 16- and 20-inch monitors, but Matsushita says it will offer a widescreen TV version in the future. The tube will be well suited for high definition TV, since the flat shadow mask has a very fine pitch—0.24 mm, which Matsushita claims is the finest ever achieved in a color CRT.

Zenith claims to hold the basic patent on the tension shadow mask and it is silent as to whether it has granted a license to Matsushita. However, it is known that the Japanese company consulted Zenith engineers during PF development.

## Sony's Plasmatron

For a truly flat tube, Sony says it will offer its "Plasmatron" wall-hanging TV next year to mark its 50th anniversary. Developed by Tektronix with input from Sony, Plasmatron combines the principles of plasma and liquid crystal displays. Unlike conventional plasma displays which use gas discharge to provide the light source, Plasmatron uses gas discharge as an electrical on/off switch, with an external backlight for illumination. The plasma switching turns the

LCD pixels on and off, passing or blocking the light. The display has a horizontal plasma channel for each scanning line—about 450 lines for an NTSC picture.

Sony says Plasmatron can be made in sizes from 20 to 50 inches, and the panels, which measure only 0.15 inch thick, can be made relatively cheaply. The company displayed a prototype widescreen 25-inch TV measuring three inches in overall depth, weighing about 3-3/4 pounds. The second model will have a 40-inch screen. Sony declines to estimate the price of the Plasmatron TV, but an official noted that it would be introduced as a home product, in the consumer price range. Sony said the tube can be produced inexpensively, with high yields and provides a picture with high brightness and contrast.

## TV Via phone line

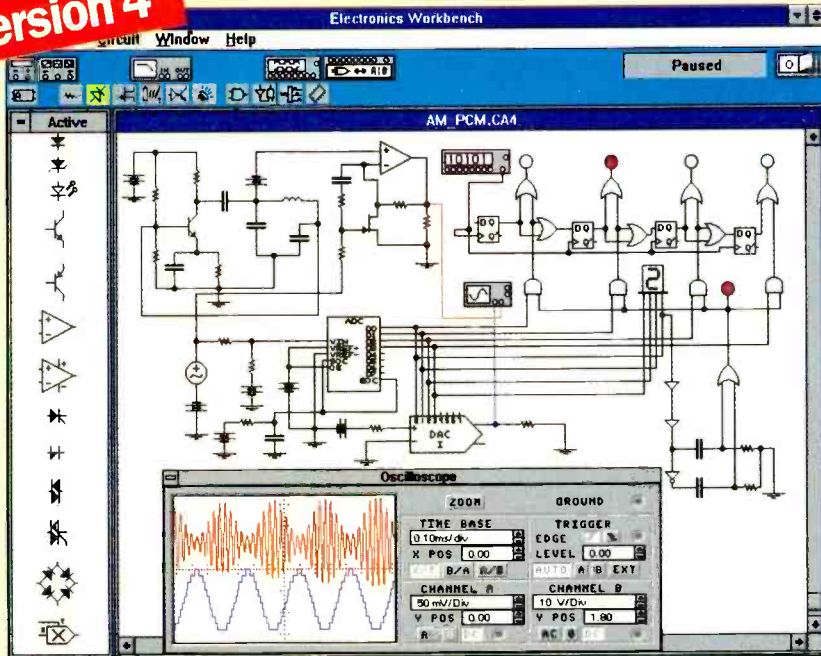
Terk Technologies has taken out a license under a package of six patents granted to Inline Connection Corp. of Arlington, VA. Inline's seemingly impossible feat of squeezing television and hi-fi audio signals into a standard phone line is based on the fact that the video output of a VCR or satellite receiver is relatively strong, compared with the signal needed for the antenna input of a TV set. While a high frequency signal introduced into a twisted-pair telephone line is quickly attenuated, enough of the strong signal remains over a relatively short line to fall within the tolerance range of a TV's antenna input. Field tests have shown that clear pictures and undistorted sound can be sent through about 300 feet of home telephone wiring. **EN**



# MIXED-MODE SIMULATION

## Design & Verify Faster with Electronics Workbench®

**New  
Version 4**



### Analog, Digital & Mixed Circuits

Electronics Workbench® Version 4 is a fully integrated schematic capture, simulator and graphical waveform generator. It is simple to mix analog and digital parts in any combination.

### Design and Verify Circuits... Fast!

Electronics Workbench's simple, direct interface helps you build circuits in a fraction of the time. Try 'what if' scenarios and fine tune your designs painlessly.

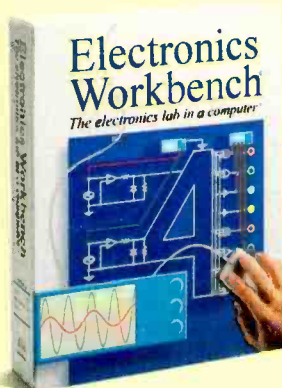
True mixed-mode simulation: Simultaneous AM transmission, digitization and pulse-code modulation of a signal.

Electronics Workbench delivers the power you need to design and verify analog, digital and true mixed mode circuits. Over 20,000 customers have already put Electronics Workbench to the test. The result: Better designs... Faster. And over 90% would recommend it to their colleagues.

Electronics Workbench will save you time and money. We guarantee it.\*

# Call Now: 800-263-5552

\*30 day money-back guarantee  
Free unlimited technical support



**Electronics Workbench \$299**

Includes: • Schematic capture  
• Simulator  
• Graphical waveform generator  
• 350 models  
+ 15 S/H

**Engineer's Pack \$599**

Includes: • Electronics Workbench  
• 2,000 Extra Models  
• Export/Import to/from SPICE  
• Export to PCB packages  
+ 15 S/H

Yes, I'm interested in  
**Electronics Workbench.**

Name: \_\_\_\_\_

Title: \_\_\_\_\_

Organization: \_\_\_\_\_

Address: \_\_\_\_\_

Phone: \_\_\_\_\_

I prefer to be contacted by e-mail/fax at: \_\_\_\_\_

9EA1FP5

**INTERACTIVE IMAGE TECHNOLOGIES LTD.**  
908 Niagara Falls Blvd. #068,  
North Tonawanda, NY 14120-2060  
Telephone: 416-977-5550  
FAX: 416-977-1818  
Email: ewb@interactiv.com  
CompuServe: 71333,3435  
BBS: 416-977-3540



Trademarks are property of their respective holders. Offer is in U.S. dollars and valid only in the United States and Canada.

Australia: 2519393 • Brazil: 11453558 • Cyprus: 2621068 • Czech Republic: 19224308 • Denmark: 33250109 • Finland: 02975033 • France: 14909900 • Germany: 711627740 • Greece: 15249981 • Hungary: 12150082 • India: 115441343  
Indonesia: 214721730 • Israel: 36475613 • Italy: 114375549 • Japan: 333823136 • Malaysia: 37742189 • Mexico: 55935260 • Netherlands: 180917666 • New Zealand: 92674756 • Norway: 22167045 • Portugal: 18146609  
Singapore: 7772302 • Slovenia: 61317890 • South Africa: 33168309 • South Korea: 222223631 • Spain: 15553234 • Sri Lanka: 1865970 • Sweden: 87405500 • Taiwan: 88623660080 • Thailand: 6624986952 • UAE: 4459505 • UK: 205233216

CIRCLE 126 ON FREE INFORMATION CARD

www.americanradiohistory.com



# Q & A

READERS QUESTIONS, EDITORS ANSWERS

## Capacitor Dot Code

**Q** I repair TVs and radios and have occasionally come across capacitors that use a dot code to indicate their value. I've been unable to find a listing of these dot codes in any of the data books I have and I'm not even sure if this method of marking capacitor values is used any longer. How do you read the capacitor dot codes?—A. Brownstone, Philadelphia, PA

**A** I haven't seen dot codes used in years but fortunately I never throw anything out. This information was sent by W. Saliba of Middleton, MA and you should save it because I don't know where else you'll be able to find it.

There were two dot codes used: a three-dot and a six-dot system. Since the former is only a subset of the latter, I'm listing only the six-dot system. The EIA introduced this system for mica capacitors and if you see only three dots, the capacitor is understood to be rated at 500 volts DC with a +/- 20% tolerance.

The complete dot code is shown in Fig. 1. You'll most likely see this kind of coding only in old radios and other vintage equipment. A similar marking system was also used for inductors but I haven't been able to find it anywhere.

## Password Swap

**Q** We have a problem with a small Novell network in our office. The network is working but someone inadvertently changed the supervisor's password, so we can't make any changes to the network. Is there any way to get the supervisor's password back without

re-installing the entire network?—G. Fisch, Nebap, NY

**A** It's inconceivable to me that someone could change the supervisor's password inadvertently—It's just not that easy to do. In any event, all is not lost because there are a few options. All rights and passwords are kept in the network's bindery which is made up of three files located in the SYSTEM directory on the file server. These are NET\$VAL.SYS, NET\$PROP.SYS, and NET\$OBJ.SYS. Novell marks these files as transactional so there's no way you can do anything to them from a workstation.

A backup that was made before the supervisor's password was changed isn't enough. You won't be able to restore the bindery files because you need supervisory privi-

leges to do so. The only way to get around this problem is to back up all the current data, then destroy all of the data on the server, reinstall the network starting with the backup that was made with the correct password, and then restore the newly saved data. Once this is done you can log in as a supervisor and restore the rights and passwords from your pre-problem backup.

If you don't have a backup containing the correct passwords, there are still two ways you can solve the problem. The first way is to back up the current data, rebuild the network, and then restore the data. You'll have to recreate the groups and users by hand but if your network is small enough, that isn't too difficult. The second method is a lot "sneakier", with access to the file server, it's a lot faster, too.

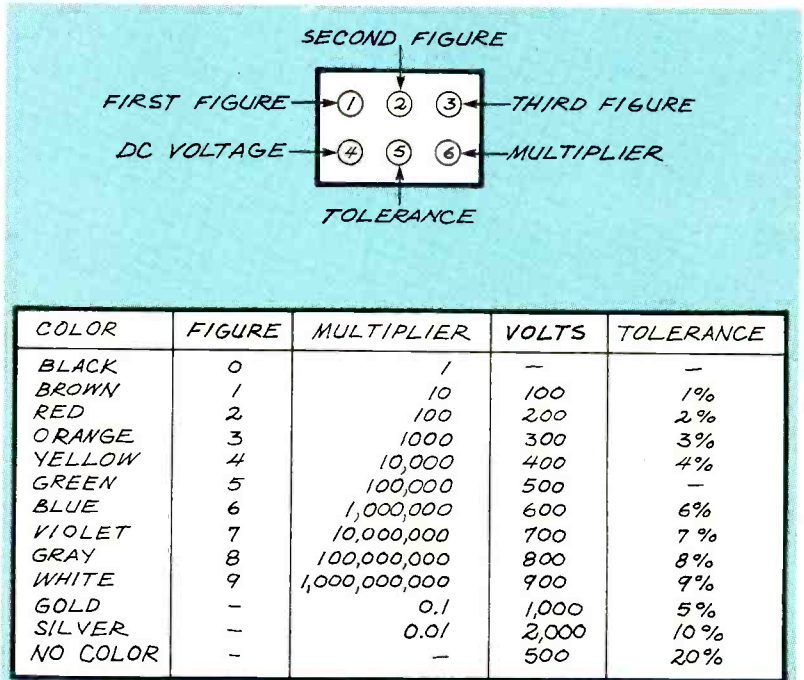


FIG. 1—CAPACITOR DOT-CODE SYSTEM. If you see only three dots, the capacitor is understood to be rated at 500 volts DC with a +/- 20% tolerance.

# Be a high-paid computer service technician

Train With NRI — America's #1 Choice in Computer Training

Only NRI gets you inside a powerful 486DX2/66 MHz Intel-based computer system you keep—giving you the hands-on experience you need to work with, troubleshoot, and repair today's most widely used computer systems. There's no more affordable way to start a money-making career, even a business of your own, as a computer service technician.

## Rely on the original -- NRI

Over a decade ago, NRI pioneered at-home training in computer servicing. Today, NRI offers the *only* computer servicing course with real-world experiments using state-of-the-art computer equipment and professional diagnostic tools.

There's no doubt about it: Working "hands-on" with all the most sought-after technology gives you practical skills and lasting confidence. Performing key tests and demonstrations, you're able to see for yourself how things work, what can go wrong, and how you can fix it.

## Train with and keep the most advanced computer in home study today

NRI's unique training has you explore a top-notch computer system and its peripherals, beginning with the 486DX2 Intel CPU and Pentium Overdrive-ready motherboard.

Your computer features 8 meg RAM, 420 meg hard drive, and fax/modem to store, receive, and send huge amounts of data.

You'll also appreciate the brilliant display of your Super VGA color monitor, the drama of your CD-ROM drive and 16-bit sound card, as well as the cutting-edge technology of Windows 95.

Plus learn to use Ultra-X professional diagnostic hardware and software to pinpoint problems on any IBM-compatible machine.

## No experience needed, NRI builds it in

Studies show that jobs for computer service technicians will be up by 38% in the next 10 years. Even if you've never worked with

**NEW!**  
486DX2/66 MHz  
Multimedia PC and  
Windows 95



computers before, NRI's interactive training builds such a solid foundation of know-how and practical experience that tomorrow's jobs can be yours.

Right from the start, hands-on experiments reinforce concepts presented in NRI's bite-sized lessons. And because your work is reviewed by your personal instructor, you know for certain that you can apply theory to real-world demands.

## FREE NRI catalog tells more

Send today for your free, full-color catalog describing every aspect of NRI's innovative computer training in the up-and-coming field of your choice.

IBM is a registered trademark of the IBM Corporation. R.A.C.E.R. and QuickTech-PRO are registered trademarks of Ultra-X, Inc.

## YOU GET EVERYTHING YOU NEED FOR SUCCESS

### POWERFUL 486DX2/66 MHz INTEL-BASED COMPUTER

Features IBM compatibility, 8 meg RAM, Pentium Overdrive-ready motherboard, and math coprocessor

### SUPER VGA COLOR MONITOR

With .28mm dot pitch for high-resolution graphics and tilt-swivel base

### 420 MEG HARD DRIVE

For greater data storage capacity and data access speed

### EXCITING MULTIMEDIA PERIPHERALS

Double-speed CD-ROM drive, 16-bit sound card with speakers, and reference CD

### FAX/MODEM

Gives you access to a world of on-line information

### ULTRA-X DIAGNOSTIC PACKAGE

R.A.C.E.R. plug-in card and QuickTech-PRO software help you detect problems on virtually all IBM-compatible machines, even if computer is 5% operational.

### NRI DISCOVERY LAB

Complete breadboarding system lets you design and modify circuits, diagnose and repair faults

### DIGITAL MULTIMETER

Professional, hand-held test instrument for quick and easy measurements

### WINDOWS 95

The time-saving operating system that everyone will be using tomorrow

If the coupon is missing, write to: NRI Schools, McGraw-Hill Continuing Education Center, 4401 Connecticut Avenue, NW, Washington, DC 20008.

## SEND TODAY FOR FREE NRI CATALOG!



McGraw-Hill Continuing Education Center  
4401 Connecticut Avenue, NW, Washington, DC 20008



Check one **FREE** catalog only

MICROCOMPUTER SERVICING

Computer Programming

TV/Video/Audio Servicing

Desktop Publishing & Design

LAN Specialist

Bookkeeping and Accounting

Programming in C++ with Windows

Check for details on career courses approved under GI Bill

Name (please print)		Age
Address		
City	State	Zip

Accredited Member, National Home Study Council

0003-0995

Reboot the server from a DOS boot floppy and use a disk editor to search for the Novell directory on the server's hard drive. Tools that allow this come with the Norton Utilities, PC Tools, and other utility packages. Search for the string "NET\$" to locate the directory entries for the bindery. Be sure that you get to the directory. A few hits will be found near the beginning of the disk because there are some text files on the small DOS partition that contain the same string.

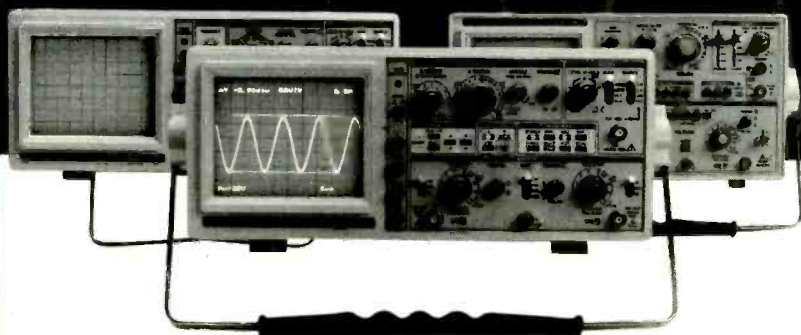
Once you've located the directory entries, change the names of the bindery files from ".SYS" to ".OLD." The Novell Netware operating system maintains two copies of the server directory, so you'll have to change a total of six file names. If you don't change all of them you'll get an error when you try to reboot the server.

After you've changed the names of the bindery files, reboot the file server. When Netware sees that there's no bindery, it will create a new one with just a supervisor and guest as users.

Log in as the supervisor (no password needed), and run BINDFIX.EXE. This will rename the .OLD files from the original bindery to .SYS making them the current bindery.

The supervisor's password will now be the unknown one again, but since you're logged in as the supervisor, you'll be able to run SYSCON.EXE and change the supervisor's password to whatever you want. You shouldn't attempt this procedure unless you're familiar with using a disk editor, have done a current backup, and have experience doing network maintenance. Although this procedure can fix the network if it's done properly, it can also totally mess it up. If you're not 100% sure you can do this, hire someone who can.

# WAVE GOODBYE TO PRICEY TEST EQUIPMENT



GoldStar offers a comprehensive line of affordable Analog and Digital Storage Oscilloscopes for your diagnostic needs.

- Signal Delay Lines
- Variable Holdoff
- TV Sync
- Max. Sweep Time of 2ns/div.

Digital Storage with CRT Readout and Cursor Control	Analog CRT Readout and Cursor Control	Analog
OS-3020: 20 MHz, 20 MS/s	OS-902RB: 20 MHz, Delayed Sweep	OS-9020A: 20MHz, Basic
OS-3040: 40 MHz, 20 MS/s	OS-904RD: 40 MHz, Delayed Sweep	OS-9040D: 40MHz, Delayed Sweep
OS-3060: 60 MHz, 20 MS/s		OS-9060D: 60MHz, Delayed Sweep
		OS-8100A: 100MHz, Delayed Sweep
		OS-9020G: 20MHz with 1MHz Function Generator

Don't forget the other sensibly priced instruments available from GoldStar (Sweep Function Generators, Frequency and Universal-Counters, Bench Power Supplies, and Bench and Handheld-Digital Multimeters).

**LG Precision**  
The Sensible Source

13013 East 166th St., Cerritos, CA 90701 310-404-0101 fax: 310-921-6227

CIRCLE 179 ON FREE INFORMATION CARD

## NPN Dilemma

I am having a problem in trying to use a transistor as a switch in a circuit. I'm using an NPN transistor and it always inverts the signal at the base. Is there a simple way for me to get it to the voltage I need?—E. Greenberg, Los Angeles, CA

Transistor switches are standard components in any designer's arsenal. As you can see in Fig. 2, the sense of the signal from an NPN transistor

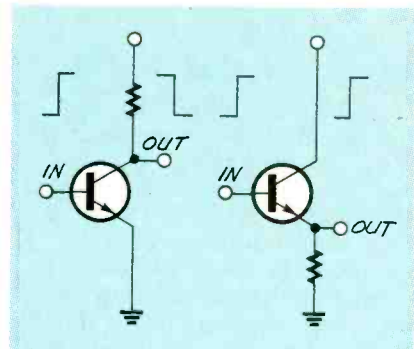


FIG. 2—THE SENSE OF THE SIGNAL from an NPN transistor depends on where you take the output from. If you take the signal from the collector, the signal at the base will be inverted. If you take the signal from the emitter, the output will have the

depends on where you take the output from. The standard way to do this, and the one you've obviously used, is to take the signal from the collector. This will invert the signal from the

Continued on page 51

# Electronics Paperback Books

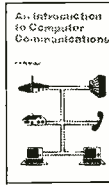
## How to Use Op Amps



□ **BP88—How to Use OpAmps...\$5.95.** A designer's guide that covers operational amplifiers. Serving as both a source book of circuits and a reference book for design calculations. The text is non-mathematical and easy to understand by most readers.



□ **BP113—30 Solderless Breadboard Projects-Book 2...\$5.95.** Companion to BP107. Presented in exactly the same style using "Verobloc" breadboards. All the breadboard projects in this book are based on CMOS logic integrated circuits.



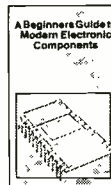
□ **BP177—Introduction to Computer Communications...\$5.95.** Details on types of modems and their suitability for specific application, plus details of connecting various computers to modems, and modems to the telephone system.



□ **BP350—Electronic Board Games...\$6.00.** Twenty novel electronic board games that you can build from the plans in this book. Some games are motor racing, searching for buried treasure or for gold in Fort Knox, — there is something for you to build and enjoy!



□ **BP61—Beginners Guide to Digital Techniques...\$5.00.** Covers the basics of digital techniques—decimal, binary, octal and hexadecimal numbering systems are covered plus insights on weighted and non-weighted binary-coded-decimal codes and alphanumeric codes. The basic building blocks of circuit logic, the common AND, OR, NAND, NOR and EXCLUSIVE-OR gates and bi-stables are thoroughly covered.



□ **BP285—A Beginners Guide to Modern Electronic Components...\$6.50.** It is easy for newcomers to electronics to become confused. There are a great many different types of components available often with numerous variations of each type. This book presents the reader with a vast amount of invaluable parts information to enable the right component to be selected every time for repairs and projects.



□ **PCP103—Practical MIDI Handbook...\$9.95.** The Musical Instrument Digital Interface (MIDI) is surrounded by a great deal of misunderstanding. This book is aimed at musicians and technicians who want to explore the vast capabilities of MIDI. It covers MIDI-based equipment you can use: keyboards, drum machines, sequencers, effects units, mixers, drum pads guitars. There's also a section on computer music.



□ **PCP119—Electronic Music and MIDI Projects...\$14.95.** Save cash by building the MIDI gadgets you need. Want a MIDI Thru box, program change pedal, Metronome, analog echo unit? Over 16 practical and very useful music and MIDI projects.



□ **BP121—How to Design and Make Your Own PCBs...\$5.75.** Simple methods for copying printed-circuit board designs from magazines and books on to copper. Covers all aspects of simple PCB construction as comprehensively as possible.



□ **BP44—IC 555 Projects...\$5.95.** Every so often a device appears that is so useful that one wonders how life went on before without it. The 555 timer integrated-circuit chip is one such device. Included are basic and general circuits used by most hobbyists.



□ **PCP109—Everyday Electronics Data Book...\$10.00.** An invaluable source of electronics information—the text contains sections that deal with the underlying theory of electronic circuits and a wide range of practical electronic uses for everyone.



□ **BP301—Antennas for VHF and UHF...\$6.00.** From installing a TV or FM antenna to setting up a multi-antenna array for shortwave listening or amateur radio, this book explains the basics of VHF and UHF antenna operation and installation. The text describes in easy-to-understand terms the essential information about how antennas work, the advantages of different antenna types, and how to get the best performance.



□ **BP297—Loudspeakers for Musicians...\$6.25.** Contains all the information that a working musician needs to know about loudspeakers: the different types, how they work, the most suitable for different instruments, for cabaret work, and for vocals. It gives tips on constructing cabinets, wiring up, available fittings, finishing and how to connect multi-speaker arrays, etc. Includes ten enclosure designs with plans.



□ **PCP110—Electronic Power Supply Handbook...\$10.95.** All types of power supplies used for electronics purposes are covered in detail, starting with cells and batteries and extending by way of rectified supplies and linear stabilizers to modern switch-mode systems, IC switch-mode regulators, DC-converters and inverters. The devices, their operating principles and typical circuits, are dealt with in detail.



□ **BP254—From Atoms to Amperes...\$6.50.** Explains in crystal-clear terms the fundamentals behind the whole of electricity and electronics. Really helps you to understand the basis of the complex subject perhaps for the first time ever.



□ **PCP101—Practical Digital Electronics Handbook...\$9.95.** An introduction to digital circuits, logic gates, bi-stables, timers, micro-processors, memory and I/O devices. A special feature of the book is the section on digital test gear projects.



□ **BP315—Introduction to the Electromagnetic Wave...\$5.95.** A fundamental and easy-to-understand approach to a complicated theory topic. The beginner requires no more than elementary mathematics and basic knowledge of electronics.



□ **#228—Essential Theory for the Hobbyist...\$5.25.** Supplies to the hobbyist background knowledge tailored to the specific requirements of the hobbyist. Relevant material is presented in a readable manner with minimum mathematics.

## TEST EQUIPMENT SPECIALS

- **BP239—Getting the Most from Your Multimeter...\$5.95**  
Covers analog and digital gear, component and gear testing.
- **BP267—How to Use Oscilloscopes & Other Testing Equipment...\$6.95**  
Get with the next step to proficient troubleshooting.
- **PCP111—Electronic Test Equipment Handbook...\$13.95**  
The all-purpose, all-pro handbook that covers basics to in-circuit testing.

## SUBSTITUTION GUIDES FOR HOBBYISTS

- **BP85—International Transistor Equivalents Guide...\$7.50**  
The ultimate guide to replacing foreign and domestic transistors.
- **BP108—International Diode Equivalents Guide...\$5.95**  
Rectifiers, Zeners, LEDs, OCIs, diacs, triacs...all hobby types.
- **BP140—Digital Equivalents and Pin Connectors...\$12.50**  
A master reference for builders who design projects.

**ELECTRONIC TECHNOLOGY TODAY INC.**  
P.O.: BOX 240, Massapequa, NY 11762-0240

Name \_\_\_\_\_  
Address \_\_\_\_\_  
City \_\_\_\_\_ State \_\_\_\_\_ Zip \_\_\_\_\_  
PE6

SHIPPING CHARGES IN USA AND CANADA	
\$0.01 to \$5.00	.....\$2.00
\$5.01 to \$10.00	.....\$3.00
\$10.01 to \$20.00	.....\$4.00
\$20.01 to \$30.00	.....\$5.00
\$30.01 to \$40.00	.....\$6.00
\$40.01 to \$50.00	.....\$7.00
\$50.01 and above	.....\$8.50

**SORRY No orders accepted outside of USA & Canada**

Total price of merchandise	..... \$ _____
Shipping (see chart)	..... \$ _____
<b>Subtotal</b>	..... \$ _____
Sales Tax (NYS only)	..... \$ _____
<b>Total Enclosed</b>	..... \$ _____

Number of books ordered

**All payments must be in U.S. funds!**



# LETTERS

SEND YOUR COMMENTS TO THE EDITORS OF ELECTRONICS NOW MAGAZINE

## POWER CONTROL CIRCUIT CORRECTIONS

*Some errors were introduced in the figures of "Power Control Circuits" (Electronics Now, June 1995). In Fig. 3, the collector of Q2 collector should be wired to the junction of diodes D1 and D2, and in Fig. 4, the polarity of diode D5 has been reversed.*

*In Fig. 5, transformer T1's secondary voltage value of 6.3 volts was omitted, and the emitter of transistor Q1 is incorrectly shown connected directly to the "hot" side of the AC power line. It should be connected to the isolated, low-voltage point at the top of resistor R1. —Ray Marston*

## LASER TURNTABLE

In the July 1995 "Q&A" column, reader John Leahy asked if a laser-based phonograph was available. Q&A correctly mentioned the publicity surrounding the Finial laser turntable and the fact that it failed to reach the market in the late 1980s. You might be interested in knowing that the story didn't end there.

When the U.S.-based manufacturer was unable to make the product economically so that it could be sold at an attractive price, the developers took the prototype to Japan. They found a small Japanese specialty manufacturer willing to make it. The laser turntable is now in limited production, and is available from a Japanese company called ELP.

The turntable is made in two versions: The LT-1L plays 33- and 45-rpm records, and the enhanced LT-1X can also play a broad range

of 78-rpm records. The LT-1X also has an outboard equalization box for the many recording "standards" that were used in the early days of recording. The turntable will play only black records—not those that have colors or pictures.

The LT-1L is priced in Japan at 2.1-million yen (about \$25,000 US), and the LT-1X is priced at 3-million yen, or \$35,000. However, before Mr. Leahy becomes too discouraged, I suggest that he contact Andy Obst, 5 Timberline Ridge, Los Alamos, NM 87544. He is in contact with ELP and can assist in the importation of a laser turntable at a reasonable price.

STEVEN L. SETO  
Chesterfield, MO

## LEAD-ACID BATTERY SELF-DISCHARGE

I have read about several solutions to the problem of self discharge of a lead-acid battery when it is stored on a cold concrete surface in this column ("Q&A," *Electronics Now*, April 1995). All of them are wrong! The solution to the problem is a simple method for circulating the electrolyte.

My knowledge of battery self

Write To:  
Letters,  
Electronics Now Magazine,  
500 Bi-County Blvd.,  
Farmingdale, NY 11735

Due to the volume of mail we receive, not all letters can be answered personally. All letters are subject to editing for clarity and length.

discharge under the conditions discussed in the article is based on several years of work with submarine storage batteries.

Self discharge of batteries is caused by temperature gradients in the battery electrolyte and is called *electrolyte stratification*. When a battery is stored on a cold surface, the lower parts of the cells are cooled to a temperature that is lower than the upper parts. That temperature differential causes a drop of the specific gravity of the cooler part of the cells at the rate of 0.004 points of gravity per 100° F of temperature change above or below 80° F.

The voltage produced by a cell is proportional to the specific gravity of the electrolyte. This difference of specific gravity between the top and bottom of a cell results in a potential difference that is proportional to the specific gravities of the two parts of the cell.

An electrical current will flow between any differences in electrical potentials, so a current will circulate through the cell plates from the top to the bottom of the cell. Those currents will persist as long as a temperature differential exists, and they can be enough to discharge the battery over time, as if it were connected to a constant load.

Devices called percolator tubes inside the cells controlled that condition in submarine storage batteries (where the steel hull immersed in ocean water provides a massive heatsink). A stream of air bubbles passed through the percolator tubes circulated electrolyte from the bottom to the top of the cells, maintaining constant specific gravity of the electrolyte.

FARNHAM M. CORNIA  
Toledo, WA

## RESISTOR RATINGS

Bill Stiles' letter (*Electronics Now*, June 1995) illustrates the practical benefits for readers of the circuits and projects published in *Electronics Now*. However, one item that caught my eye in that issue was the DPM design with a high range of 2000 volts DC.

Anyone building a high voltage voltmeter must be aware that resistors

Type	Code	Rating (Watts)	Volts Max.	Volts Derate
Metal Film	RN55	1/10	200	160
	RN60	1/8	250	200
	RN65	1/4	300	240
	RN70	1/2	350	280
Carbon Film	RC05	1/8	150	120
	RC07	1/4	250	200
	RC20	1/2	350	280
	RC32	1.0	500	400
	RC42	2.0	500	400

have maximum voltage ratings based on the flashover voltage limit of the resistance element. That value is not the same as the maximum voltage which relates to rated power dissipation ( $E^2/R$ ), because it is limited by case size rather than by its value.

Thus, the voltage divider for the high-voltage ranges might require many series resistors to prevent the voltage rating of each individual resistor from being exceeded when making measurements.

The maximum voltage ratings of carbon and metal film resistors are listed in Table 1. For safety's sake, those numbers should be derated by a factor of 0.8 (i.e., limit a 200-volt resistor to 160 volts). Table 1 shows that to build a 2000-volt DC DPM with 1/4-watt, 1% metal-film resistors, the high-voltage divider should be made up of 10 series resistors:

2000 volts DC/200 volts per resistor = 10 resistors.

Also for product safety, a low leakage current Zener diode should be placed across the input leads of the DPM. If the ground-side resistor of the high-voltage divider opened without the Zener diode there, full voltage would appear across the DPM's input.

CHARLES HANSEN  
Tinton Falls, NJ

## THE DEMISE OF SWEEP ALIGNMENT

I'd like to offer a more precise answer to the question, "Sweep Alignment A Lost Art?" in the June 1995 "Q&A."

Sweep alignment died because of the introduction and rapid acceptance of the *surface acoustic wave* (SAW) filter more than 20 years ago. Developed for the communications, SAW filters gained wide acceptance in television receivers because they offer precise bandwidth and can't be adjusted. If the device is out-of-limits, you simply replace it.

The SAW filter is based on piezoelectric principles. If a signal is applied to an input section on a piezoelectric crystal substrate (made from such materials as lithium niobate or quartz), a surface wave will propagate across the substrate and be picked up by an output section at the other end of the material.

A SAW substrate is typically about 0.15-inch square. By carefully controlling the length and spacing (weighting) of the input and output sections, a filter with the desired bandwidth is produced.

DOUGLAS L. MOORE  
Oklahoma City, OK

## LASER SHOW ENHANCEMENTS

In reference to the article "Laser Light Show" (*Electronics Now*, April 1995), Omega offers several enhancements for the project. The number of images available can be quadrupled by adding DPDT polarity-reversing switches for any two of the motors.

The addition of specialized laser-optical elements for the passage of the image before, between, or after the mirrors will add image multiplication, diffusion, blurring or amorphousness, and other effects. Effective elements include diffraction gratings, nebulizers, and lumia.

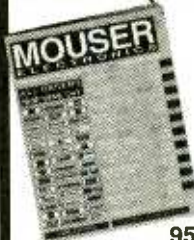
Since 1978, Omega has offered two kits containing these optical elements for laser light-show experimenters. OMEGA ORGANIZATION INTERNATIONAL  
Box 33623  
Seattle, WA 98133-0623

# 54,123

## ELECTRONIC COMPONENTS

Whether you order 1 part or all 54,123...MOUSER stocks and...ships same day!!

CALL... (800) 992-9943



for your  
FREE  
CATALOG

958 North Main St.  
Mansfield, TX 76063

## MOUSER<sup>®</sup> ELECTRONICS

Sales & Stocking Locations Nationwide

CIRCLE 117 ON FREE INFORMATION CARD

## Be an FCC LICENSED ELECTRONIC TECHNICIAN!



No costly school. No commuting to class. The Original Home-Study course prepares you for the "FCC Commercial Radiotelephone License." This valuable license is your professional "ticket" to thousands of exciting jobs in Communications, Radio-TV, Microwave, Maritime, Radar, Avionics and more...even start your own business! You don't need a college degree to qualify, but you do need an FCC License.

**No Need to Quit Your Job or Go To School** This proven course is easy, fast and low cost! **GUARANTEED PASS**—You get your FCC License or money refunded. **Send for FREE facts now. MAIL COUPON TODAY!**

Or, Call 1-800-932-4268 Ext. 90

### COMMAND PRODUCTIONS

FCC LICENSE TRAINING, Dept. 90  
P.O. Box 2824, San Francisco, CA 94126  
Please rush FREE details immediately!

NAME \_\_\_\_\_  
ADDRESS \_\_\_\_\_  
CITY \_\_\_\_\_ STATE \_\_\_\_\_ ZIP \_\_\_\_\_



# EQUIPMENT REPORTS

FIELDPIECE HS24K15 STICK METER FIELDPACK.

*Now you can carry  
five tools in one.*

CIRCLE 15 ON FREE INFORMATION CARD



Field service technicians require test equipment that's specially designed for making measurements on the go. The equipment should be as light as possible, yet afford plenty of versatility. It should be designed to make troubleshooting as convenient out in the field as it would be at a test bench.

Fieldpiece Instruments, Inc. (231 E. Imperial Highway Suite 250, Fullerton, CA 92635, 714-992-1239) specializes in manufacturing multimeters and accessories that cater to field use. In particular, the HS24 Stick Meter has a logic-probe design that is extremely versatile and makes it easier to do troubleshooting without the benefit of a test bench. Especially convenient is Fieldpiece's HS24K15 Nylon Fieldpack, which contains the HS24 meter and four accessories in a convenient nylon carrying case.

The HS24 Stick Meter is housed in a rugged yellow plastic case with two input jacks on one end that are normally used for test leads or probe tips. Four head-like attachments included with the HS24K15 kit slide onto the end of the meter and adapt it for new functions.

The ACH current clamp head slides onto the meter and lets it

inductively measure up to 300 amperes AC. The ARH1 relative humidity head lets the meter directly measure relative humidity from 10% to 95% RH. The ATH3 temperature head has switchable inputs for two K-type thermocouples and lets the meter display from -50 to 1800° F. The AUA1 microamp head lets the meter measure current in microamperes. The stick meter and all mentioned attachments, plus all necessary test leads and accessories in a nylon carrying case costs \$418. All items are also available separately.

## The Fieldpack

Most readers can probably relate to the following situation: You have to measure a voltage with a standard multimeter and there's no convenient flat surface around to rest the meter on. Finally you locate a spot where the meter will rest only to find that the test leads don't reach where you want them to. After a bit more juggling you get the leads to reach only to realize that you can't see the display on the meter when you hold the probes in position. Clearly, something other than a regular DMM would be more ideal for troubleshooting in awkward locations.

Fieldpiece's HS24 Stick Meter is a more ideal instrument for field

use than a common DMM. The HS24 is a 3½-digit multimeter that can measure AC and DC volts, resistance, capacitance, check diodes, and perform audible continuity tests. There are four AC voltage ranges of 200 millivolts, 2000 millivolts, 200 volts, and 750 volts. There are three DC voltage ranges of 200 millivolts, 2000 millivolts, and 200 volts. There are two resistance ranges of 200 ohms and 200 kilohms, and one capacitance range of 200 microfarads. The meter is shaped more like a logic probe or a skinny remote control than a DMM. It fits comfortably in one hand, and the single rotary control and two pushbuttons—hold and reset—can be operated easily with the thumb. It is powered by a 9-volt battery.

The top end of the HS24 has two input jacks for either special probe-type tips or standard test leads. The most convenient setup for field use, however, is where a test lead with an alligator clip on the end connects to common and a probe-type tip is used for the hot input. That way the ground lead is attached to a convenient location and the meter is used like a logic probe to make measurements. With the meter in your hand right where a measurement is being made, the display is always easy to see.

The jaws of the ACH current clamp open to accommodate a single conductor of up to 23 millimeters in diameter. The head inductively measures AC amperes and converts them to millivolts AC. It slides onto the end of the stick meter, which must be set to one of its two millivolt AC ranges. The current clamp head lets the meter



display up to 300 amperes AC at a frequency between 40 and 500 hertz.

The ARH1 relative humidity head converts relative humidity percent to millivolts DC. A black plastic tube with a semiconductor humidity sensor built in is mounted on the end of the



THE RELATIVE HUMIDITY HEAD is one of the more interesting stick meter attachments

humidity head. With the stick meter set to its 200-millivolt DC range, and the relative humidity head attached, the meter will directly display relative humidity from 10% to 95% RH. The relative humidity head contains its own 9-volt battery.

The ATH3 temperature head converts temperature to millivolts DC. The head has switchable inputs for two K-type thermocouples included with the HS24K15 set. A three-position switch makes the stick meter, set to a millivolt DC range, display either the T1 thermocouple input temperature, the T2 input, or a  $\Delta T$  display that shows the difference between the two temperature inputs. The temperature head has a conversion range from  $-50$  to  $1800^\circ$  F. Two externally accessible potentiometers allow the two temperature inputs to be calibrated simply by placing the thermocouple tips in ice water and setting the display to read 32. The temperature head also contains a 9-volt battery.

The AUA1 microamp head converts microamperes DC to millivolts DC. It works with the stick meter set to its 200-millivolt DC range. The microamp head has two input leads with spade lugs on the ends for connections to other circuitry.

The HS24K15 kit comes with all necessary test leads, two K-type thermocouples, and a rugged nylon carrying case.

With a price of \$418 for the entire kit, the HS24K15 is a good value especially when compared with what it would cost if all items were purchased individually. And the \$418 buys quite a bit of testing capabilities. Field service technicians, especially those who work in the heating ventilation and air conditioning (HVAC) industry, will find the set extremely useful.

EN

# HC Protek The Next Generation of High Performance DMM's

Model 506



### Featuring:

- True RMS Mode
  - 3 3/4 Digit, 4000 Count
  - Dual Display for Frequency, AC Voltage and Temperature
  - RS-232C Interface
  - 10 Location Memory
  - Decibel Measurement
  - Pulse Signal Injection
  - Inductance and Capacitance Measurement
- and, of course, Panel Backlight, Min-Max, Logic Test and many more features.

Euro Suite 6117 - EDS "95

ISO 9001 CERTIFIED

HC Protek

154 Veterans Drive, Northvale, NJ 07647  
Tel: (201)767-7242 Fax: (201)767-7343

CIRCLE 185 ON FREE INFORMATION CARD



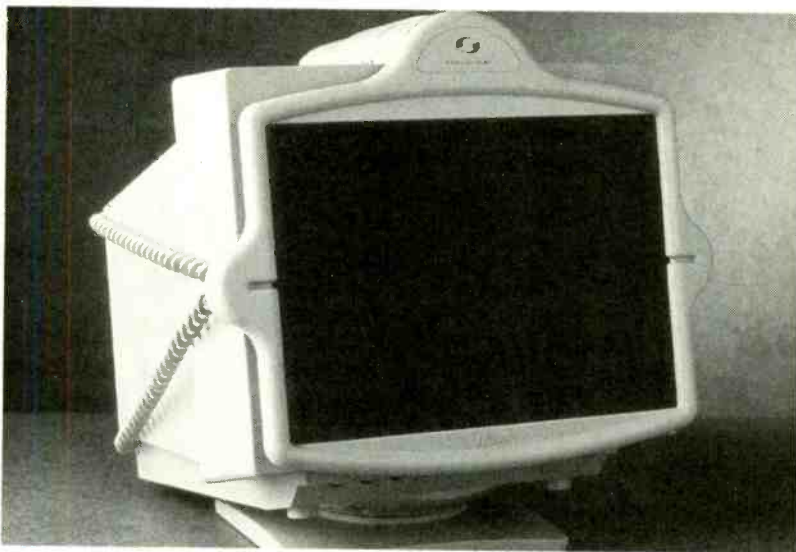
# NEW PRODUCTS

USE THE FREE INFORMATION CARD FOR FAST RESPONSE

## RADIATION-PROTECTION/ANTI-GLARE SCREEN

THE KEMMA RPS (RADIATION Protection System) monitor screen from Connectware, Inc. is intended to protect computer users from the possible health hazards of very low frequency (VLF) electrical and magnetic fields.

screen controls radiation emissions by sensing the monitor's magnetic signature and responding to it. The magnetic field from the monitor's deflection coils is canceled. After adjustment for specific monitor's topology, the radiation-protection



CIRCLE 20 ON FREE INFORMATION CARD

The Kemma screen is based on a proprietary, active magnetic canceling principle that is said to reduce the magnetic field around a computer monitor. The manufacturer claims that the product is an improvement over standard anti-glare screens that block electrical fields but do not screen out magnetic fields. Its claim is based on tests of the screen conducted in Sweden. VLF magnetic radiation was reduced by 85% at a distance of 24 inches from the screen and by up to 99% 40 inches away.

The screen can be installed easily over 14- and 15-inch monitors. Electronic circuitry at the top of the

screen adapts automatically to video mode changes.

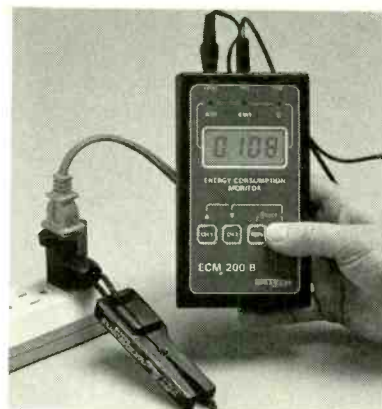
The Kemma RPS screen is priced at \$199.00

### CONNECTWARE INC.

1301 East Arapaho  
Richardson, TX 75081  
Phone: 214-907-1093  
Fax: 214-907-1594

## POWER CONSUMPTION MONITOR

THE ECM-200 POWER CONSUMPTION monitor from Jensen Tools provides a safe, and reliable



CIRCLE 21 ON FREE INFORMATION CARD

way to determine AC electrical power consumption. It can locate abnormal energy-consuming products, detect overloaded circuits, and identify equipment that should be repaired.

The monitor has probes that clamp around the insulation of a cable to sense a fraction of the voltage being monitored. If local electricity unit cost per kilowatt-hour is entered, the ECM-200 displays incremental costs of power consumed, total time the load has been monitored, the kilowatt hours consumed, and instantaneous power in kilowatts.

The monitor is based on the same method employed by utilities to compute consumption values. It provides a readout of "true power" rather than "apparent power." An optional clamp-on probe allows 240-volt power or a second cable to be monitored.

The ECM-200 with a monitor, clamp-on probe, wall-outlet adapter, AC adapter, and manual, all in a case, is priced at \$349.00.

### JENSEN TOOLS INC.

7815 South 46th Street  
Phoenix, AZ 85044-5399  
Phone: 1-800-426-1104

## Just like these Fully Trained Electronics Professionals



"Thanks to CIE I have tripled my previous salary, and I am now in a challenging and rewarding new field where only the sky is the limit."

Daniel Wade Reynolds  
Industrial Electrician  
Ore-Ida Foods



"CIE was recommended to me by my boss. It was appealing since I could study at my own pace at home and during business travel."

Dan Parks  
Marketing Manager/Consumer Products  
Analog Devices, Inc.



"I loved the flexibility CIE offered. It was the only way I could continue both school and my demanding job."

Britt A. Hanks  
Director of Engineering  
Petroleum Helicopters, Inc.



"I liked the way the school was set up with laboratory assignments to enforce conceptual learning. The thing which impressed me the most about CIE's curriculum is the way they show application for all the theory that is presented."

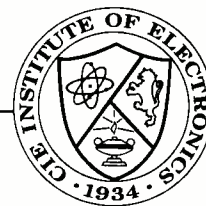
Daniel N. Parkman  
Missile Electro-Mechanical Technician  
U.S. Air Force



"Completing the course gave me the ability to efficiently troubleshoot modern microprocessor based audio and video systems and enjoy a sense of job security."

Tony Reynolds  
Service Manager/Technician  
Threshold Audio & Video

# Graduate with an Associate Degree from CIE!



CIE is the best educational value you can receive if you want to learn about electronics, and earn a good income with that knowledge. CIE's reputation as the world leader in home study electronics is based solely on the success of our graduates. And we've earned our reputation with an unconditional commitment to provide our students with the very best electronics training.

Just ask any of the 150,000-plus graduates of the Cleveland Institute of Electronics who are working in high-paying positions with aerospace, computer, medical, automotive and communications firms throughout the world. They'll tell you success didn't come easy...but it did come...thanks to their CIE training. And today, a career in electronics offers more rewards than ever before.

### CIE'S COMMITTED TO BEING THE BEST...IN ONE AREA...ELECTRONICS.

CIE isn't another be-everything-to-everyone school. CIE teaches only one subject and we believe we're the best at what we do. Also, CIE is accredited by the National Home Study Council. And with more than 1,000 graduates each year, we're the largest home study school specializing exclusively in electronics. CIE has been training career-minded students for nearly sixty years and we're the best at our subject...  
**ELECTRONICS... IT'S THE ONLY SUBJECT WE TEACH!**

### CIE PROVIDES A LEARNING METHOD SO GOOD IT'S PATENTED.

CIE's AUTO-PRO-GRAMMED® lessons are a proven learning method for building valuable electronics

career skills. Each lesson is designed to take you step-by-step and principle-by-principle. And while all of CIE's lessons are designed for independent study, CIE's instructors are personally available to assist you with just a toll free call. The result is practical training... the kind of experience you can put to work in today's marketplace.

### LEARN BY DOING...WITH STATE-OF-THE-ART EQUIPMENT AND TRAINING.

CIE pioneered the first Electronics Laboratory



Course and the first Microprocessor Course. Today, no other home study school can match CIE's state-of-the-art equipment and training. And all your laboratory equipment, books and lessons are included in your tuition. It's all yours to use while you study and for on-the-job after you graduate.

### PERSONALIZED TRAINING...TO MATCH YOUR BACKGROUND.

While some of our students have a working knowledge of electronics others are just starting out. That's why CIE has developed twelve career courses and an A.A.S. Degree program to choose from. So, even if you're not sure which electronics career is best for you, CIE can get you started with core lessons applicable to all areas in

electronics. And every CIE Course earns credit towards the completion of your Associate in Applied Science Degree. So you can work toward your degree in stages or as fast as you wish. In fact, CIE is the only school that actually rewards you for fast study, which can save you money.



## YES!

I want to get started. Send me my CIE course catalog including details about the Associate Degree Program. (For your convenience, CIE will have a representative contact you - there is no obligation.)

Please Print Clearly

Name \_\_\_\_\_

Address \_\_\_\_\_

City \_\_\_\_\_

State \_\_\_\_\_ Zip \_\_\_\_\_ Age \_\_\_\_\_

Phone No. \_\_\_\_\_

Check box for G.I. Bill Benefits.

Veteran  
 Active Duty

**AE79**

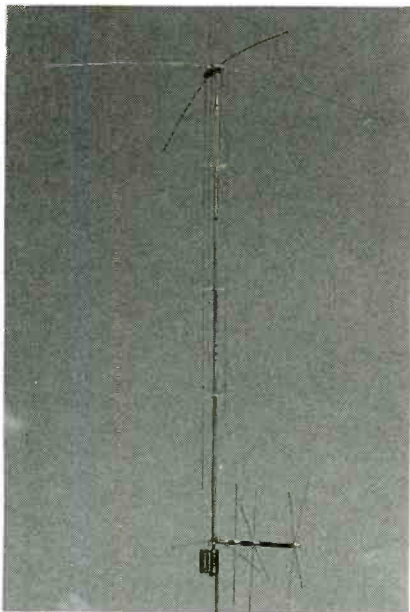
Cleveland Institute of Electronics, Inc.  
1776 East 17th Street  
Cleveland, OH 44114

A School of Thousands.  
A Class of One. Since 1934.

Send for CIE's FREE Course Catalog and See How We Can Help Your Career Too!

## TEN-BAND ANTENNA

THE MFJ-1798 ANTENNA IS designed to receive ten radio bands: 75/80, 40, 30, 21, 17, 15, 12, 10, 6, and 2 meters. Self-supporting and without the need for ground or radials, the



CIRCLE 22 ON FREE INFORMATION CARD

antenna is 20-feet high. It is equipped with separate full-size radiators, and operates with end loading. It features elevated top feed, low radiation angle, and wide bandwidth.

The MFJ-1798 also offers fully automatic bandswitching, omnidirectional coverage, low SWR, and 1500 watts PEP SSB power output. Its elevated top feed maximizes radiation high up on the antenna for increased range. It is made of fiberglass rod and aluminum tubing.

The antenna can be mounted easily on the ground, a tower, or a rooftop. Tuning is said to be easy, and its frequency adjustments are nearly independent of each other. The adjustment of one band has a minimal effect on the resonant frequencies of other bands.

The MFJ-1798 10-band antenna is priced at \$269.95.

**MFJ ENTERPRISES, INC.**

*P. O. Box 494*

*Mississippi State, MS 39762*

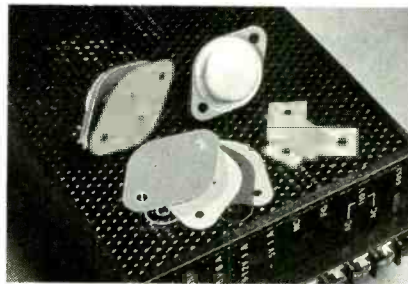
*Phone: 601-323-5869*

*(for orders: 1-800-647-1800)*

*Fax: 601-323-6551*

## POWER DEVICE INSULATORS

POWER DEVICE INSULATORS from Bivar, Inc., are insulating wafers intended to shield components from heat and prevent short circuits. Made from Underwriters Labora-



CIRCLE 23 ON FREE INFORMATION CARD

tories-rated, flame-retardant materials in a range of thicknesses, the insulators are compatible with the following power transistor and diode packages: TO-3, TO-66, TO-218, TO-220, TO-247, DO-4, and DO-5.

The insulators are shipped loose or on rolls with thermally conductive, pressure-sensitive adhesive backing. They are thin enough so that they add little to component height.

# N.E.W.

## National Electronic Wholesalers

# CHIPS

**Jerrold Compatible**  
 DP5, DPV5...as low as \$5.00  
 DP7, DPV7 ..as low as \$7.00  
 R2, V5, CFT modules from \$15.00

**Scientific Atlanta**  
 Quick-Boards for:  
 8550, 8570, 8580, 8590, 8600  
 all as low as \$14.75

ALSO AVAILABLE FOR TOCOM, PIONEER AND ZENITH

# 1-800-639-6369

CIRCLE 182 ON FREE INFORMATION CARD

# SALE!

## CABLE TV

### DESCRAMBLERS

### WE'LL BEAT ANY PRICE!

### CALL TOLL-FREE

## 1-800-284-8432

- JERROLD • TOCOM • ZENITH •
- OAK • PIONEER • HAMLIN •
- SCIENTIFIC ATLANTA •

24 HOUR SHIPMENTS!  
 QUANTITY DISCOUNTS!  
 30 DAY MONEY BACK GUARANTEE!  
 FREE CATALOG & INFORMATION

Mastercard • American Express • Visa • C.O.D.  
 HAVE MAKE AND MODEL NUMBER OF EQUIPMENT USED IN YOUR AREA

### 1-800-284-8432

FOR ORDERS ONLY  
 For technical & customer service: 305-749-3122  
 ALL SHIPPING & HANDLING FEES AT CUSTOMER'S EXPENSE  
 Anyone implying theft of service will be denied assistance.

### CABLE WAREHOUSE

10117 WEST OAKLAND PARK BLVD., SUITE 315, SUNRISE, FL 33351  
 NO FLORIDA SALES

CIRCLE 187 ON FREE INFORMATION CARD

Power Device Insulators are priced at \$84 per thousand in 10,000-piece lots. Inquire about smaller-volume pricing, outline dimensions, tolerances, and materials.

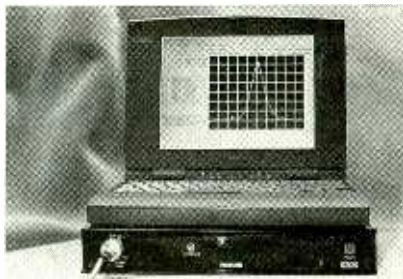
**BIVAR, INC.**

4 Thomas  
Irvine, CA 92718-2593  
Phone: 714-951-8808  
Fax: 714-951-3974

**SINGLE-BOARD COMPUTER**

THE FLASHLITE SBC SINGLE-board computer from JK Microsystems is a computer board that offers DOS pre-loaded in flash-memory. Intended as an embedded computer, the SBC board can be programmed in languages such as QuickBASIC or Tiny Basic, making it a suitable development platform. Any assembler or compiler that generates DOS-compatible EXE or COM files is suitable for firmware development.

The on-board V-25 Plus processor provides two serial ports, two DMA channels, two timers, 24 parallel I/O lines, and eight analog comparators. The board also contains 512 kilobytes of RAM and 256 kilobytes of flash memory. Connectors are provided for all of the V-25 I/O signals and the processor address and data bus.



CIRCLE 24 ON FREE INFORMATION CARD

With 128 kilobytes of program storage and 512 Kilobytes of processor memory, many different applications can be developed with Microsoft QuickBASIC and QuickC and Borland Turbo Basic and Turbo C.

The Flashlite SBC includes a flash-disk format program, an X-modem file-upload program, a text editor, and a Tiny Basic interpreter. A 32-page user's manual, a Quick-Start guide, and complete schematics are included.

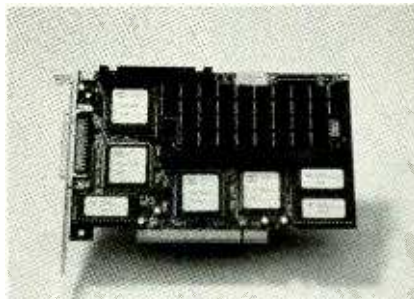
The Flashlite SBC is \$195.00.

**JK MICROSYSTEMS**

1275 Yuba Avenue  
San Pablo, CA 94806  
Phone: 510-236-1151  
E-mail: jkmicro@dsp.com

**PCI-TO-SCSI CACHING ADAPTER CARD**

THE CSA-6520 PCI BUS-TO-SCSI caching adapter card from CMD Technology offers from 4 to 64 megabits of user-installable cache memory based on a single 72-pin, industry-standard SIMM memory.



CIRCLE 25 ON FREE INFORMATION CARD

Each controller includes Windows FastDisk driver support, QuickSCSI software, CMD's "Tag RAM" caching architecture, and ASPI Manager. Windows FastDisk support allows the number of windows available to be expanded while operating within each window at optimum speeds.

QuickSCSI software integrates the PCI-Bus and any SCSI disk, tape, or optical device. Tag RAM supports up to 64 megabits of user-installable SIMM memory. The caching adapter card also supports command queuing and up to seven SCSI IDs and eight LUNs per ID. It also interfaces with SCSI-1, SCSI-2, Fast, and Fast/Wide peripherals.

The SCA-6520 caching adapter card with a user's manual, installation software, SCSI cable, full O/S drivers, and a copy of Corel SCSI is priced at \$399.00

**CMD TECHNOLOGY INC.**

1 Vanderbilt  
Irvine, CA 92718  
Phone: 714-454-0800  
or 1-800-426-3832

Continued on page 83

**Electronic Security**

2 for 1 SALE!



**Mini Long Range FM Voice Transmitter (3 mi) Ultra Sensitive** - with fine tune, range control, more! Detects even whispers! FMX1 Kit and Plans.....~~\$49.90~~



**Tiny Telephone FM Transmitter (3 mi)** - automatically operates when phone is used. Crystal clear clarity with fine tune and range control. TELX-1 Kit and Plans.....~~\$39.90~~

**Both Easy-to-Build Kits Above only \$49.50!**

**Extended Play Telephone**



**Recording System - \$129.50**

- Automatic - Crystal Clear - Easy to Use - Connects to Any Phone - Automatically controls and records both sides of the conversation on our extended play recorder. Caution - check local laws as some states require an alerting beeper.

TAP20X Ready-to-Use System ..... only \$129.50

FREE CATALOG with order - or send \$1.00 P&H

**INFORMATION UNLIMITED** MC, VISA, Check, Cash or C.O.D. Send or Fax Orders to: Dept en16 PO Box 719, Amherst, NH 03031

Orders: 800-221-1705 FAX 603-672-5406 Tel 603-673-4730

**Earn \$1000**

**A Week While You Learn High Paying VCR Repair.**

Earn While You Learn . . . Secrets Revealed . . .



**Train at Home**

If you are able to work with small hand tools and possess average mechanical ability, you could earn top dollar part time or full

time. Our learn by doing method teaches you how to work on VCR's without boring unnecessary electronic basics.

**For Free Information Package Send Coupon to:**  
Foley-Belsaw Institute, 6301 Equitable Road, Kansas City, MO 64120

Check VCR or another High Paying Career Field (Check One Box Only)

VCR Repair, Dept. 62371  
 Computer Repair, Dept. 64268  
 TV/Satellite Dish, Dept. 31147  
 Advance VCR Repair, Dept. 65053  
 Camcorder Repair, Dept. 66063  
 Fax Repair, Dept. 67063  
 Printer Repair, Dept. 68062  
 Computer Programming, Dept. 35095

**FOLEY BELSAW**  
Since 1926

Name \_\_\_\_\_  
 Address \_\_\_\_\_  
 City \_\_\_\_\_  
 State \_\_\_\_\_ Zip \_\_\_\_\_

CIRCLE 184 ON FREE INFORMATION CARD

October 1995, Electronics Now

## Two ways to fit a 100 MHz



**Bigger hands.**



Got huge hands? Then you probably don't mind lugging a benchtop scope around in the field. For the rest of us, there's TekScope™, the revolutionary oscilloscope/DMM from Tektronix. It's the first hand-held to offer true 100 MHz bandwidth and a 500MS/s sample rate on each of its two channels.

benchtop scope in your hand.



**TekScope™**

That's enough power to capture fast single-shot pulses. Plus it's got the familiar Tek interface and a bright, backlit display—all for just \$2195 MSRP. For the name of your nearest Tektronix distributor, call us at 1-800-479-4490, action code . Or visit our Web site at <http://www.tek.com>.

**Tektronix**



# NEW LITERATURE

USE THE FREE INFORMATION CARD FOR FAST RESPONSE

## The Quantum Dot: A Journey into the Future of Microelectronics

by Richard Turton.  
Oxford University Press  
198 Madison Avenue  
New York, NY 10016  
**\$25.00**



CIRCLE 337 ON FREE INFORMATION CARD

Turton's book provides a clear look at the science and engineering behind today's high-density microelectronics devices. The author explains the evolution of

the integrated circuit by starting with a primer on atoms and electrons, and then going into a discussion of the properties of semiconductor materials. Finally he explains the role of the transistor as a discrete device and its place as the building block of most integrated circuits. You'll also learn how transistors and other circuitry are integrated into various semiconductor wafers.

Turton explains how more functions are being packed on a minuscule silicon chips that are smaller than a fingernail by ever finer photolithographic processes. He then takes the reader through an overview of the modern global microelectronics industry and its mutual interdependency, commenting on the latest semiconductor substrate materials and techniques. As an aside, he discusses the technology behind the latest superconducting materials whose resistance values disappear at temperatures

that are getting closer to room temperature.

The book offers an intriguing glimpse into the future of microelectronics, explaining the relevance of quantum theory and how physical events at micrometer scale contradict intuitive perceptions. Turton explains some of the alternatives to the transistor and how they take advantage of quantum effects in incredibly small and fast devices. You will learn about "designer atoms" and the "quantum dot."

The author predicts the development of devices whose operation will depend on the electron's wave rather than particle characteristics and photonic computers that perform data manipulation, storage and transmission with light beams.

## The Downloader's Companion for Windows

by Scott Meyers and Catherine Pinch.  
Prentice Hall PTR  
Englewood Cliffs, NJ 07632  
Phone: 1-800 947 7700  
**\$19.95**



CIRCLE 338 ON FREE INFORMATION CARD

This book and diskette package tells you all you need to know about downloading computer files and getting the most out of them. It includes all the software you will need to download files

quickly with an easy-to-use

Windows interface. Files that can be downloaded are usually in a form that are not compatible with your computer. They could be compressed, archived, encoded, or possibly all three. This book and diskette will help you translate both text and graphics files into usable formats.

The book includes valuable insider tips that will save the reader expensive on-line time that could be wasted by fiddling with trial and error methods for downloading files. The disk contains software such as WinZip, a compression/uncompression program that works with most common archive formats.

The package also provides quick-file viewers and instructions for accessing files in several formats. For pictures they include GIF, JPEG, BMP, and TGA, for sounds and music they include WAV, VOC, and AU, and for movies you get MPEG.

## CD-ROM Catalog

Walnut Creek CD-ROM  
4041 Pike Lane, Suite D-386  
Concord, CA 94520

free



CIRCLE 339 ON FREE INFORMATION CARD

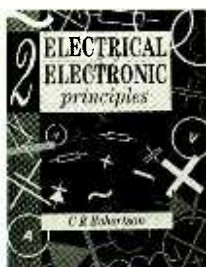
This full-color catalog describes a wide assortment of CD-ROMs available from Walnut Creek for most computer operating systems. These include Windows, DOS, Unix, Mac, and OS/2. Many



of the CD-ROMs are also BBS-ready. Among the titles offered are the QRZ! Ham Radio CD-ROM, with more than 643,000 names, addresses, and call signs, The Scientific and Technical Library, Hobbes OS/2 Archived, Ready to Run; animations and pictures, and the Space Shuttle Encyclopedia. The catalog includes a free offer of a CD-ROM that contains samples of Walnut Creek's CD-ROMs.

## Electrical & Electronic Principles, Volume 2

by Christopher R. Robertson.  
Chapman and Hall,  
One Penn Plaza,  
41st Floor, New York, NY 10119;  
**\$22.50**



CIRCLE 340 ON FREE INFORMATION CARD

This textbook is the second volume of a two-volume course on the principles of electricity and electronics. Both volumes are intended to give students of science and engineering a firm foundation for further study and understanding of electrical and electronic devices and systems. Both volumes can serve as a valuable reference for review. The two volumes combine to form a complete set of course notes.

Among the many topics covered in Volume 2 are DC transients, single- and three-phase AC circuits, network theorems, attenuators, AC and DC machines, measurements and measuring instruments, control principles, data transmission, and modulation techniques. Most chapters contain examples that illustrate applications of the theory introduced, and they highlight specific principles. Questions at the ends of the chapters are intended to challenge the reader's understanding of the text in the chapter. Most of the questions call for mathematical solutions and, as an aid to the student, the answers appear at the end of each volume.

## Switches Plus Catalog

102 Switches Plus  
192 Pepe's Farm Roa  
Milford, CT 06460  
Phone: 1-800-792-4757  
Fax: 1-800-792-5877  
**free**



CIRCLE 341 ON FREE INFORMATION CARD

This latest catalog from Switches Plus presents the company's complete line of snap-acting switches, joystick controllers, flush-mounted pushbuttons, pulse counters, and power supplies. Other products listed include heavy-duty oil-tight and waterproof industrial-grade switches, pilot lights, tools, and accessories.

Switches Plus products have Underwriters Laboratories and international approvals, including ISO 9001 certification. The catalog includes ordering information, product descriptions, illustrations, technical specifications, and pricing.

## The Visual Guide to Visual C++

by Nancy Nicolaisen.  
Ventana Press  
P.O. Box 2468  
Chapel Hill, NC 27515  
Phone: 1-800-743-5369  
Fax: 919-942-1140  
E-mail: [orders@vmedia.com](mailto:orders@vmedia.com);  
World Wide Web:  
<http://www.vmedia.com/index.html>  
**\$29.95**



CIRCLE 342 ON FREE INFORMATION CARD

This book and its companion diskette is a guide to the development of applications for 32-bit computers. It includes an introduction to AppWizard, a tour of the resource editors, a cookbook of code examples, and a comprehensive reference to Microsoft Foundation Classes (MFCs). Photographs of computer

# EARN YOUR B.S. DEGREE IN COMPUTERS OR ELECTRONICS



## By Studying at Home

Grantham College of Engineering, now in our 45th year, is highly experienced in "distance education"—teaching by correspondence—through printed materials, computer materials, fax, modem, and phone.

No commuting to class. Study at your own pace, while continuing on your present job. Learn from easy-to-understand but complete and thorough lesson materials, with additional help from our instructors.

Grantham offers three separate distance-education programs, leading to the following accredited degrees:

- (1) The B.S.E.T. with Major Emphasis in Electronics.
- (2) The B.S.E.T. with Major Emphasis in Computers.
- (3) The B.S.C.S. — the Bachelor of Science in Computer Science.

An important part of being prepared to *move up* is holding the right college degree, and the absolutely necessary part is knowing your field. Grantham can help you both ways—to learn more and to earn your degree in the process.

Write or phone for our free catalog. Toll free, 1-800-955-2527, or see mailing address below.

Accredited by  
the Accrediting Commission of the  
Distance Education and  
Training Council

**GRANTHAM**  
College of Engineering  
Grantham College Road  
Slidell, LA 70460

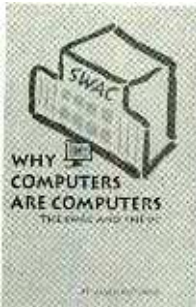
screens and step-by-step examples will steer the reader through the complexities of Visual C++.

An in-depth examination of MFC 3.0, including useful examples, is included. A complete description of the member functions within each class will help the reader to gain functional literacy in this software. Nicolaisen has included tips on when to use the functions, traps to avoid, and code examples to demonstrate the use of code.

The book explains meaning, appropriate use, and possible value for all public data members. The companion disk contains all the programming examples from the book. This will save the users' time and help them to avoid errors.

## Why Computers are Computers: The SWAC and the PC

by David Rutland.  
Wren Publishers  
P.O. Box 1084  
Philomath, OR 97370  
Phone: 502-929-4498  
Fax: 503-757-0693  
**\$24.95**



CIRCLE 343 ON FREE INFORMATION CARD

form so many different functions, the meaning of bits and bytes, and why computers are not patented, and the concept of the "stored program" computer. Other topics that are covered in the book include computer languages, the operating system and applications software.

The author was an engineer on the SWAC computer project at the University of California at Los Angeles in 1950. With 2700 vacuum tubes and weighing over a ton, SWAC was an evolutionary advancement over

the University of Pennsylvania's ENIAC. From that perspective, Rutland looks backwards to explain how calculations were made before computers. With amusing anecdotes, he takes the reader on a tour through the early history of computers, describing the inventions, events, and personalities that made computers what they are today

You will gain insights into the rise and decline of the mainframe computer, and you'll learn how the personal computer evolved from little more than a sophisticated calculator to its present role as the backbone of the computer community because of its ability to do spreadsheets, an important tool for business.

You will also see the relationship between the early SWAC and the present generation of PCs, both complex instruction set computers (CISC). He goes on to discuss alternatives to the CISC computer such as the RISC (reduced instruction set) and parallel-processing computer. He also comments on networks and the rise of worldwide computer services.

## 1995/96 Power Products Catalog

Hewlett-Packard Company  
Corporate Communications Department  
3000 Hanover Street  
Palo Alto, CA 94304  
Phone: 1-800-452-4844  
**free**



CIRCLE 344 ON FREE INFORMATION CARD

plies, electronic loads, power test systems, and solar-array simulators for the laboratory and factory. The catalog is organized to give the reader easy access to extensive listings of application information, dimensioned product drawings, illustrations of equipment front-panels, and product specifications.

## Magnum Terminal Blocks Electronic Catalog MTB1

Cooper Industries  
USD Products Division  
7300 West Wilson Avenue  
Chicago, IL 60656  
Phone: 708-867-4600  
Fax: 708-867-2211  
**free**



CIRCLE 345 ON FREE INFORMATION CARD

Magnum catalog describes the company's line of barrier-style terminal blocks and a wide selection of terminal, screw, and hardware options. The Magnum "Wire-Ready"

option is now standard on all of its single-row terminal blocks, and molded mount ends are standard on Magnum's 2000 and 3000 series terminal blocks.

Other products covered in the catalog are double-row terminal blocks, edge board connectors, and Mag-Master electronic/field wiring interfaces. Complete specifications, illustrations, photographs, and ordering information are included.

## RF Connectors Catalog

Connex Connector Corporation  
616 Fitch Avenue  
Moorpark, CA 93021  
Phone: 805-378-6464  
Fax: 805-378-6471  
**free**



CIRCLE 346 ON FREE INFORMATION CARD

This edition of the Connex Connector's catalog describes the company's line of radio-frequency connector products. Pictures and specifications of standard and special application connectors for RF and data transmission are included. Also described are Connex Connector's in-house technical services that include testing, computer-aided design, and certification.

# The Four-Year Electronics Degree Program That Really Hits Home!

Bring The Technology Home With A Bachelor Of Electronics Engineering Degree. No Hassles. No High Cost!



Now's the time to prepare for a profitable career.

## We've lowered the cost of higher education.

It's true! You can earn a four-year Bachelor of Electronics Engineering Technology degree today ... and prepare yourself for a high-paying electronics career ... without quitting your job or ever leaving your home. Because World College, an affiliate of the Cleveland Institute of Electronics, offers you the total flexibility of independent study programs proven effective for people like you who truly want to succeed! World College independent study lessons help you build valuable skills

**Mail/Fax Today  
or Call  
1-800-696-7532**

step-by-step, and expert instructors are personally available to you with a toll-free call. What a way to earn an education!

## A world of opportunity.

Where is your career headed? With a four-year bachelor's degree from World College, you call the shots, choosing from incredible, high-paying opportunities in electronics, tele communications, computer, electrical power, and many other growing fields.

World College gives you the skills, the knowledge, the power to take advantage of your best opportunity in electronics. And you can do it all at your own pace!

## Without leaving home.

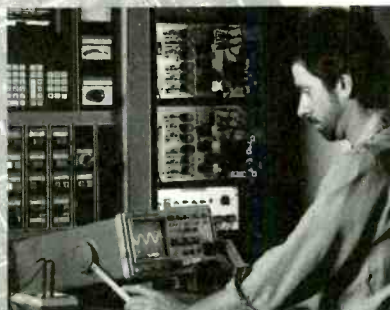
World College continually works to provide its students with the most advanced education tools. From the latest equipment and reference books to breakthrough computer-simulated experiments, students are exposed to the latest technological advancements.

All the equipment, parts, and software you need are included in your affordable tuition, including more than 300 hands-on lab experiments you can complete in your home.

## Choose your own pace.

Earn your bachelor's degree on your time — and at your pace — because you pay tuition to World College only as you complete the upper-level semesters close to graduation. The faster you make it through, the less you pay. So you have an incentive to make your future happen quickly — yet the freedom to choose your own pace!

Send today for your FREE course catalog — and give yourself that future you've always wanted — with an electronics degree education from World College.



Take charge of your future in electronics.

## Four Powerful Reasons To Connect With World College Today:

1. Earn your four-year degree!
2. Self-paced training!
3. Independent study in your home!
4. Expert instruction!

## Give Me The Power!

Send me a FREE World College course catalog today!



(Please Print Neatly)

Name \_\_\_\_\_

Address \_\_\_\_\_

City \_\_\_\_\_

State, Zip \_\_\_\_\_

Phone ( ) \_\_\_\_\_

Age \_\_\_\_\_

**For faster service, call  
1-800-696-7532,  
or call  
1-804-464-4600.**

**Or fax this coupon to  
1-804-464-3687.**



Lake Shores Plaza  
5193 Drive, Suite 113  
Virginia Beach, VA 23455-2500



Affiliated with  
Cleveland Institute of Electronics

WAE26

# RETAILERS THAT SELL OUR MAGAZINE MONTHLY

## Alaska

Frigid North Co.  
1207 W. 36th Avenue  
Anchorage, AK 99503

## Alabama

Radio Distributing Supply  
121 East Broad Street  
Gadsden, AL 35903

## Arizona

Dalis Electronics  
2829 E. McDowell Road  
Phoenix, AZ 85008

## California

California Electronics  
221 N. Johnson Ave.  
El Cajon, CA 90202

Signal Electronics  
22307 Ocean Avenue  
Torrance, CA 90505

Ford Electronics  
8431 Commonwealth Avenue  
Buena Park, CA 90621

All Electronics  
14928 Oxnard Street  
Van Nuys, CA 91411

Gateway Electronics of CA  
9222 Chesapeake Drive  
San Diego, CA 92123

Mac's Electronics  
191 South "E" Street  
San Bernardino, CA 92401

Electronics Warehouse  
2691 Main Street  
Riverside, CA 92501

Orvac Electronics  
1645 E Orangethorpe Ave.  
Fullerton, CA 92631

Sav-On Electronics  
13225 Harbor Blvd.  
Garden Grove, CA 92643

Marvac Dow Electronics  
980 S. A Street  
Oxnard, CA 93030

Kandarian Electronics  
1101 19th Street  
Bakersfield, CA 93301

Whitcomm Electronics  
105 W. Dakota #106  
Clovia, CA 93612

Marvac Dow Electronics  
265-B Reservation Road  
Marina, CA 93933

Minuteman Electronics  
37111 Post St., Suite 1  
Fremont, CA 94536

HCS Electronics  
6819 S. Redwood Drive  
Cotati, CA 94931

Halted Specialties Co.  
3500 Ryder Street  
Santa Clara, CA 95051

JDR Micro Devices  
2233 Branham Lane  
San Jose, CA 95124

Metro Electronics  
1831 J Street  
Sacramento, CA 95814

The Radio Place, Inc.  
5675-A Power Inn Road  
Sacramento, CA 95824

HSC Electronics  
4837 Amber Lane  
Sacramento, CA 95841

## Colorado

Gateway Electronics of CO  
2525 Federal Blvd.  
Denver, CO 80211

Centennial Electronics  
2324 E. Bijou  
Colorado Sps., CO 80909

## Connecticut

Signal Electronics Supply  
589 New Park Avenue  
W. Hartford, CT 06110

Electronic Service Prod.  
437 Washington Avenue  
North Haven, CT 06473

## Georgia

Norman's Electronics, Inc.  
3653 Clairmont Road  
Chamblee, GA 30341

## Idaho

The Current Source  
5159 Glenwood  
Boise, ID 83714

## Illinois

Tri State Elex  
200 W. Northwest Hwy.  
Mt. Prospect, IL 60056

## Maryland

Mark Elec. Supply Inc.  
5015 Herzel Place  
Beltsville, MD 20705

## Massachusetts

U-Do-It Electronics  
40 Franklin Street  
Needham, MA 02194

## Michigan

Purchase Radio Supply  
327 East Hoover Avenue  
Ann Arbor, MI 48104

Norwest Electronics  
43087 Plymouth Road  
Livonia, MI 48150

The Elec. Connection  
37387 Ford Road  
Westland, MI 48185

Elec. Parts Specialists  
711 Kelso Street  
Flint, MI 48506

Professional Data Corp.  
1332 US Highway 41 West  
Ishpeming, MI 49849

## Minnesota

Acme Electronics  
224 Washington Avenue N.  
Minneapolis, MN 55401

## Missouri

Gateway Electronics Of MO  
8123-25 Page Blvd.  
St. Louis, MO 63130

## New Jersey

Lashen Electronics Inc.  
21 Broadway  
Denville, NJ 07834

## New York

Computers  
7 Great Jones Street  
New York, NY 10012

Sylvan Wellington Co.  
269 Canal Street  
New York, NY 10013

Unicorn Electronics  
Valley Plaza  
Johnson City, NY 13790

## Ohio

Philcap Electronic Suppliers  
275 E. Market Street  
Akron, OH 44308

## Oregon

Norvac Electronics  
7940 SW Nimbus Avenue  
Beaverton, OR 97005

Portland Radio Supply  
234 S.E. Grand Avenue  
Portland, OR 97214

## Texas

Tanner Electronics  
1301 W. Beltline  
Carrollton, TX 75006

Mouser Electronics  
2401 Hwy. 287 N  
Mansfield, TX 76063

Electronic Parts Outlet  
17318 Highway 3  
Webster, TX 77598

## Virginia

Elec. Equipment Bank  
323 Mill Street, N.E.  
Vienna, VA 22180

Cain Electronics Co.  
1530 Ingleside Road  
Norfolk, VA 23502

## Washington

Amateur Radio Supply Co.  
5963 Corson Ave., Ste 140  
Seattle, WA 98108

## Wisconsin

Appleton Electronic Dist.  
205 W. Wis Avenue  
Appleton, WI 54911

## Wyoming

Chris Supply  
2007 S. Douglas Hwy., Ste. C  
Gillette, WY 82716

**If you'd like to sell our magazine in your store,  
please circle 210 on Free Information Card.**

# HIGH-POWER HI-FI AUDIO AMPLIFIER

***This powerful stereo amplifier outperforms commercial units. One version is for the home and the other is portable for sound reinforcement in halls, auditoriums, and theaters.***

REINHARD METZ AND MYZIL BOYCE

THE AMPLIFIER DESCRIBED IN THIS article is a lightweight, high-performance stereo amplifier for the demanding audiophile. It can be built for less than \$500 in parts, but it performs better than high-end amplifiers that cost up to ten times that amount. Its performance is comparable to top-of-the-line professional products, and also is suitable for sound reinforcement because of its portability and rugged construction.

## **System description**

Figure 1 is a block diagram for the amplifier. It consists of a pair of linear discrete amplifiers, both powered by a full-bridge, off-line, switching power supply. It is capable of providing well over 1 kilowatt of continuous power and 2 kilowatts peak with the most demanding audio loads. Both amplifier channels have MOSFET output stages rather than the more common bipolar power transistors.

The authors have found that MOSFET amplifier output stages deliver the best audio quality, but they recognize that they might not be as robust as their bipolar counterparts. That drawback was overcome in this stereo amplifier by powering it with a switching power supply. That supply contributes

significantly to the amplifier's overall high performance because of its high instantaneous current capability.

The switching power supply permits the amplifier to be made smaller and lighter than if a comparable linear power supply were used. This high-performance amplifier weighs less than 20 pounds! The power supply's operation at 75 kHz permits the use of smaller and lighter magnetic components. As is true of all switching power supplies, this power supply has smaller filter capacitors than would be required for a linear power supply. The power supply can be switched between three different output voltages. This permits operation at lower voltage or power levels for speaker protection, or to drive lower than standard impedance loads.

A comparable conventional linear power supply would require a large and expensive transformer and large and expensive filter capacitors because they charge at the relatively low frequency of the 60-Hz power line.

Moreover, this higher charge poses a constant threat of damage or destruction to the output transistors if the amplifier is subjected to excessive loads or experiences short circuits. The smaller filter capacitors

store much less energy to be dissipated if a short circuit occurs, reducing that threat.

This article discusses two different amplifier configurations: One is intended for fixed installation in the home, and the other for portable applications so that it can be carried for use in large hall or auditoriums for sound reinforcement. The package for home use depends on natural thermal convection and conduction for cooling, while the portable package includes two 3½-inch, muffin-style fans for forced air cooling. Both cases have approximately the same volume and weigh about 18 pounds. The case for the home version is 5 inches high and the case for the portable version is 3½-inches high and is designed to fit a standard 19-inch instrument rack.

Both versions include two identical amplifier circuit boards and identical switching power supplies. Both include clipping indicators, DC output protection, optional bridging and differential input adapter stages on the amplifier boards. The optional bridging feature allows the amplifier to be reconfigured into a single channel capable of driving loads up to 700 watts and differential input adapter stages permit a 600-ohm balanced input.

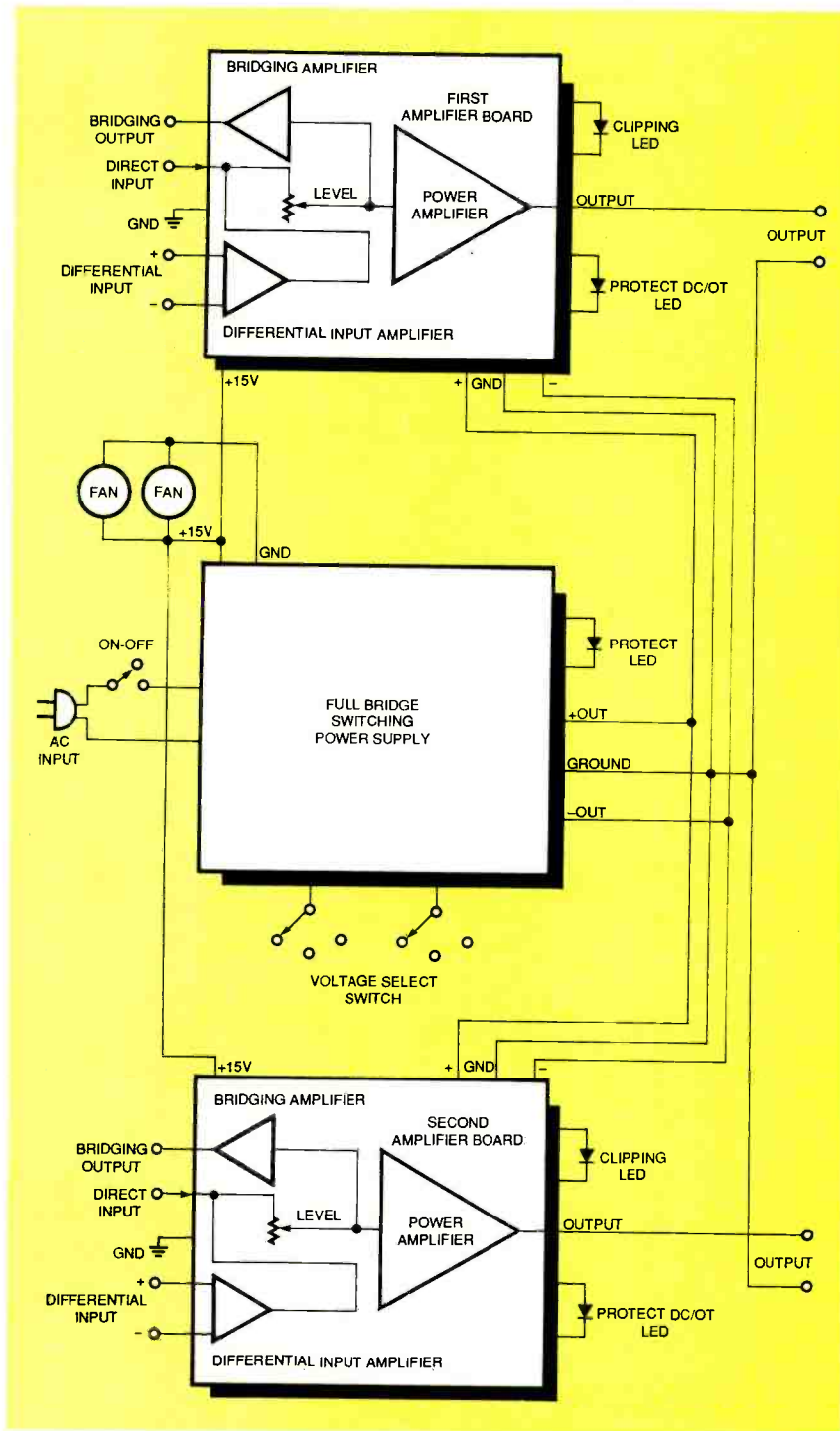


FIG. 1—BLOCK DIAGRAM OF STEREO AMPLIFIER. Designed for operation in homes or auditoriums, it contains two amplifier circuit boards and one switching power supply board.

### Performance specifications

The specifications for both versions of the amplifier are given in Table 1. When compared with the most expensive commercial amplifiers, it can be seen that these performance characteristics are outstanding. Often low distortion and

wide bandwidth are proclaimed as predictors of audio performance, yet many amplifiers whose measured performance is rated excellent will sound different. The audio purists will continue to argue about characteristics and what the specifications will or will not reveal.

The authors believe that there are discernible subjective differences between amplifiers even if the specifications do not identify them. In their view this just means that electrical measurements really don't test audio quality satisfactorily. Given otherwise favorable specifications, it has been the authors' experience that high output current capability is the most reliable predictor of subjective listening satisfaction, probably because it allows the amplifier to better handle the variations in a speaker's impedance. While the distortion and bandwidth specifications for this amplifier are commendable, the amplifier was specifically designed to optimize output current capability.

### How the amplifier works

All of the components in both amplifier channels, with the exception of the bridging inverter and differential input adapter stage, are discrete, as shown in the schematic Fig. 2. Differential input capability is provided by IC2, an LM334 constant-current source and IC5, an LF357 JFET operational amplifier inverter that drives a second channel for bridging.

The normal single-ended input signal passes through the 10  $\mu$ F input blocking capacitor C1 and the low-pass input filter network consisting of resistors R1, R2 and R3 and capacitor C2. Complementary differential input stage transistors Q1 to Q4 and transistors Q5 and Q6 along with resistors R15 and R16 provide the second gain stage. Both stages drive the complementary cascode inversion stage.

Transistors Q10 to Q13 and Q24 develop the gate bias for the output power MOSFETs. These MOSFETs, Q16 to Q23 (and optional Q26 and Q27) are mounted on aluminum angle stock that act as thermal adapters to the finned heat sink. In the home version the heatsinks form the back of the case; in the fan-cooled version they form two sides.

The inverter stage operates at

*Continued on page 69*

# Low-Cost Software For Electronics

*New low-cost software lets you draw schematics, lay out PC boards, and breadboard circuits on your desktop PC.*

LAST MONTH WE looked at several schematic drawing software packages. Most of them could be used only for drawing purposes. This month we examine some more advanced software packages, including some that can do more than just draw schematics.

## Schematic capture

The following four packages are schematic-capture programs that, in addition to drawing schematics, generate netlists of circuit parameters for exporting to other programs such as PC-board routing and circuit-simulation packages. The first two, SuperCAD Plus and WinScheme, generate netlist files that can be used by PC board layout software to create finished circuit boards. The second two, CircuitMaker and Electronics Workbench, are circuit simulators with integrated schematic capture. Prices start at \$99 for the DOS version of SuperCAD, and increase to \$299 for the integrated simulation packages.

<b>Product:</b>	SuperCAD
<b>Version:</b>	3.2 (DOS), 2.0 (Win.)
<b>Price</b>	\$99 (DOS), \$149 (Win.)
<b>Platform:</b>	DOS or Windows
<b>Publisher:</b>	Mental Automation, Inc.

SuperCAD is one of the best schematic capture programs on

the market thanks to its capable editing features: True Type fonts, ease of use, and its very low \$99 price. This program has not only survived over many years, but it has advanced without a price increase as new upgrades were released.

SuperCAD is built on a modular premise where you pay as you grow. The basic module costs only \$99 for DOS and \$149 for Windows, and you build from there, adding extra

library modules (\$59), utility software (\$69), and analog/digital simulation (\$99 each). Or you can do the smart thing, and buy the SuperCAD+ package with all the extras except circuit



TJ BYERS: Circuit Win

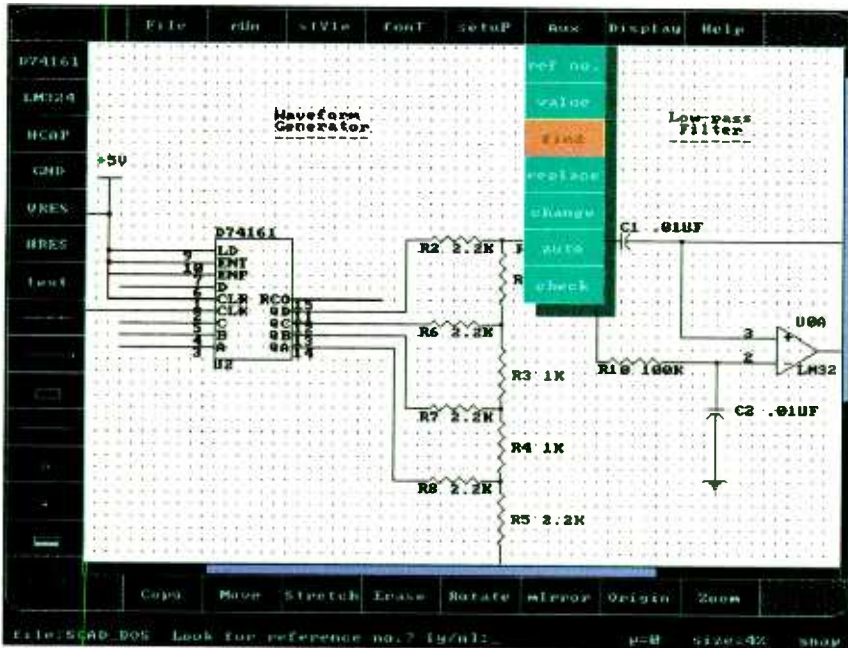


FIG. 9—SUPERCAD FOR DOS is an excellent schematic capture program with advanced features like auto wiring and find.

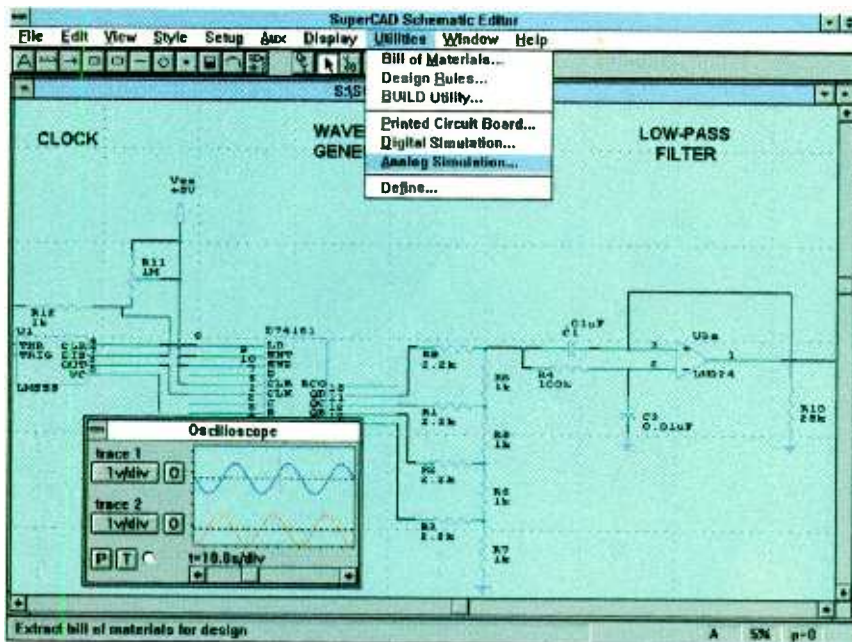


FIG. 10—AS WITH OTHER VERSIONS of the program, SuperCAD + for Windows works with both digital and analog external simulators via compatible netlists and built-in waveform displays.

ited, but not moved.

Drawing wires is simple with the auto wiring feature, but you must be careful about how you make wiring connections. For the netlist to recognize a connection, it must be made at a legal (though invisible) termination point. Despite the fact that the program lets you tap into the component's rather lengthy pin wire, it's not a legal connection although it looks like one on the schematic.

The latest version of SuperCAD+ for Windows features a Multiple Document Interface (MDI) that allows up to 20 schematics to be loaded at once for easy access. Also up to 20 schematics can be included in a project group for easy handling—plus you can perform automated design checking and update reference designators.

Now the bad news. While the schematic capture program is among the best, and the related analog and digital simulation programs are dirt cheap (starting at \$99), you're going to have to dredge up \$149 for the companion PC board layout software (\$299), if you opt for the autorouter and autoplacement options, and that gives you only two copper layers on a small 8 × 8-inch board. If you must create multilayer boards, it'll cost you \$499 for the PC board layout software. Alternatively, you could use the netlist conversion software included in the utilities option to translate the netlist into formats that can be used with other PC board layout programs, such as OrCAD, but that's going to be expensive.

SuperCAD is a great program. It's inexpensive, extremely easy to learn and use, and generates a bill of material, has circuit simulation, and PC board layout netlists. Circuit simulation is a two-way street, where simulation is tightly coupled with SuperCAD for display on oscilloscope and logic analyzer screens (see Fig. 10). And it's backed by some of the best technical support available. What more can you ask from a schematic capture program?

*Continued on page 63*

simulation for just \$199 (DOS) or \$249 (Windows). The following describes SuperCAD+ for Windows; if you're interested in the DOS version, see Fig. 9.

SuperCAD+ for Windows' symbols libraries are spread over several directories and subdirectories, and contain more than 2600 schematic symbols. The library menus have preview areas, where you can look at the symbol before placing it on the drawing. This is handy when

the library doesn't contain the exact component needed, but it has something closely resembling it that can easily be modified by the library editor. Once a symbol is selected from a library, it can be placed repeatedly. Reference designators are assigned after placement either globally or one at a time. Assigning part values is done after placement, too, as is rotation and mirroring of parts. Attached nomenclature can be ed-



BY NOW, JUST ABOUT EVERYONE has heard about home theater, and anyone who has had the pleasure of hearing a demonstration can appreciate the incredible sound that home-theater systems can deliver. Unfortunately, those great sounding systems usually have high price tags. In this article, you will see how to save big bucks by building your own subwoofer—usually one of the most expensive home-theater components.

Many people have already started to experiment with home theater by connecting a television set or VCR to the auxiliary inputs of a stereo system. In most cases, this simple configuration provides a terrific improvement over the TV set's built-in speakers. However, popular compact bookshelf-style stereo systems usually don't have speakers that are big enough to provide the deep bass that gives volume and power to theater sound. This important feature of home-theater sound comes from the subwoofer speaker.

Subwoofers provide a clean, deep bass that you can feel. The rumble of spaceships blasting through the galaxy in Star Wars, the musical tremors of Close Encounters, and the thundering stampede of dinosaurs trampling across Jurassic Park are just a few examples of the great movie moments that a subwoofer can bring to life.

Subwoofers can be divided into two main categories: passive and powered. Passive subwoofers generally consist of a passive crossover network and a speaker mounted in an enclosure. Although this kind of subwoofer is the least expensive, it must be powered by an external amplifier, and the amplifiers of most integrated stereo

# POWERED SUBWOOFER



***The "Little Earthquake" home-theater subwoofer delivers the deep bass you've been missing.***

**RODRICK SEELY**

systems are too small to drive a passive subwoofer adequately.

The Little Earthquake is a powered subwoofer that features an active crossover network, 50-watt power amplifier, a 10-inch driver, and a fourth-order bandpass enclosure. The built-in power amplifier enables the Little Earthquake to work with virtually any stereo system. You can build the Little Earthquake for less than \$200.

## **Circuit design**

Figure 1 is the schematic diagram of the powered subwoofer. The power supply consists of a center-tapped 48-volt transformer, bridge rectifier, and filter capacitors C7 and C8. The rectified and filtered output is about  $\pm 35$  volts. The power supply for op-amp IC1 is regulated to  $\pm 15$  volts by Zener diodes D1 and D2 and resistors R19 and R20.

Most of the circuit is built around a TL074 quad op-amp (IC1), which functions as an input buffer, bandpass filter, and output driver. The input circuit consists of a mixer and voltage divider formed by resistors R1 and R2, potentiometer R3, and unity-gain buffer IC1-a. Potentiometer R3 is provided to adjust the output of the subwoofer to the desired level. Op-amp IC1-b provides a 12 dB per octave high-pass filter with capacitors C2 and C3, and resistors R5 and R6. The cutoff frequency for this filter is  $1/2\pi RC$ , or about 34 Hz with the values shown. Resistors R8 and R7 set the gain and Q of the filter. Capacitor C1 and resistor R4 form an additional 6 dB per octave high-pass filter at about 20 Hz. A 12 dB per octave low-pass filter is formed by IC1-c, C4 and C5, and R9 and R10. The values shown set the low-pass cutoff at 72

Hz. The gain and Q of this stage are set by R11 and R12. These two filters, connected back-to-back, form a bandpass filter with the transfer function shown in Fig. 2.

The output stage operates as class-B amplifier for higher efficiency. Because the TL074 has a high slew-rate, crossover distortion commonly associated with class B amplifiers is virtually eliminated. Any distortion caused by the amplifier is in a frequency band higher than the subwoofer speaker can reproduce. When operated with  $\pm 15$ -volt supplies, the output of op-amp IC1-d can swing about 10 volts peak to drive transistors Q1 and Q2. Resistors R17 and R18 provide negative feedback, and set the gain of the output stage at about three. Hence, the output can swing to about 30 volts peak. As long as the transistors are the high-

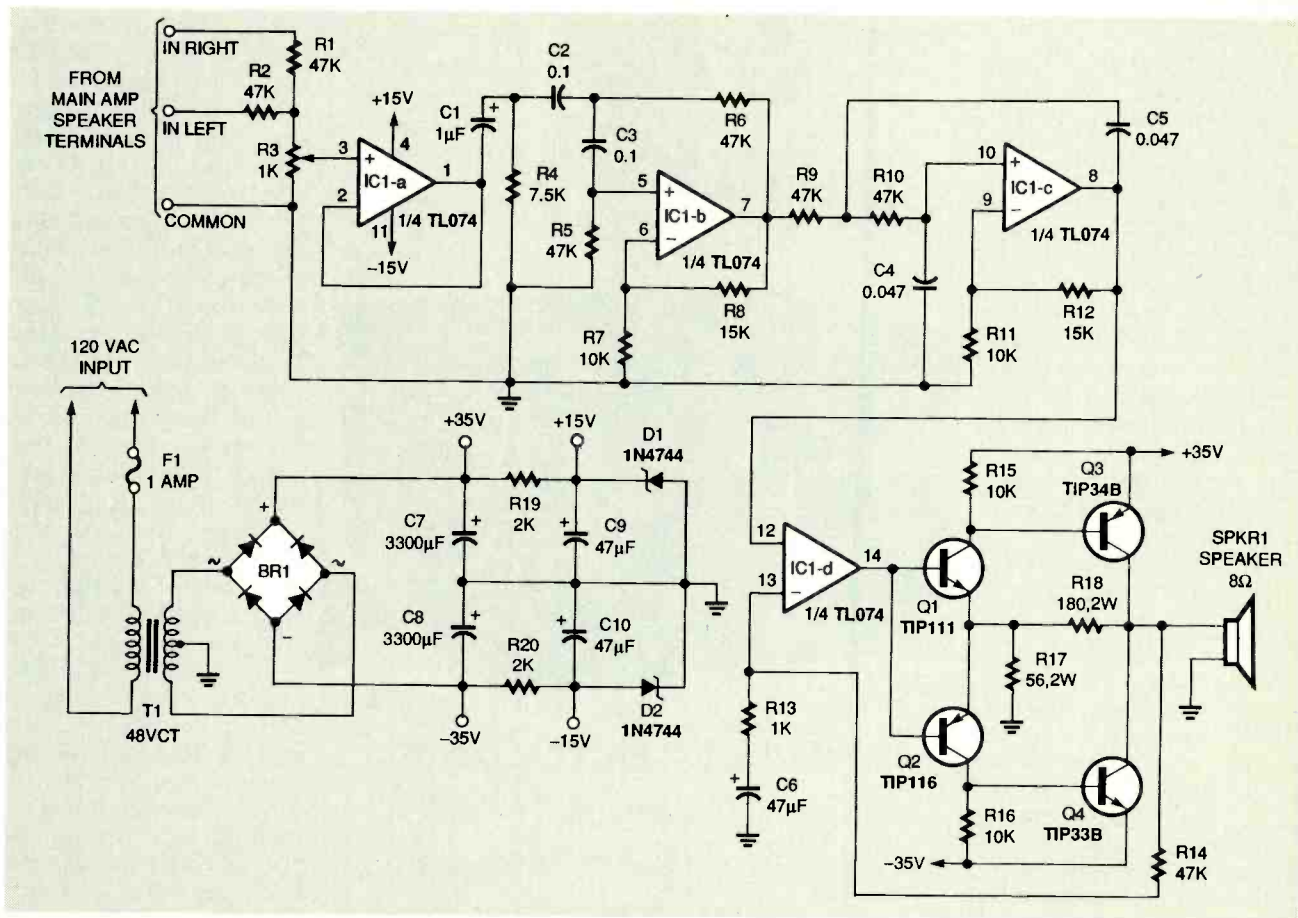


FIG. 1—SCHEMATIC DIAGRAM of the powered subwoofer. The power supply consists of a center-tapped 48-volt transformer, bridge rectifier, and filter capacitors C7 and C8.

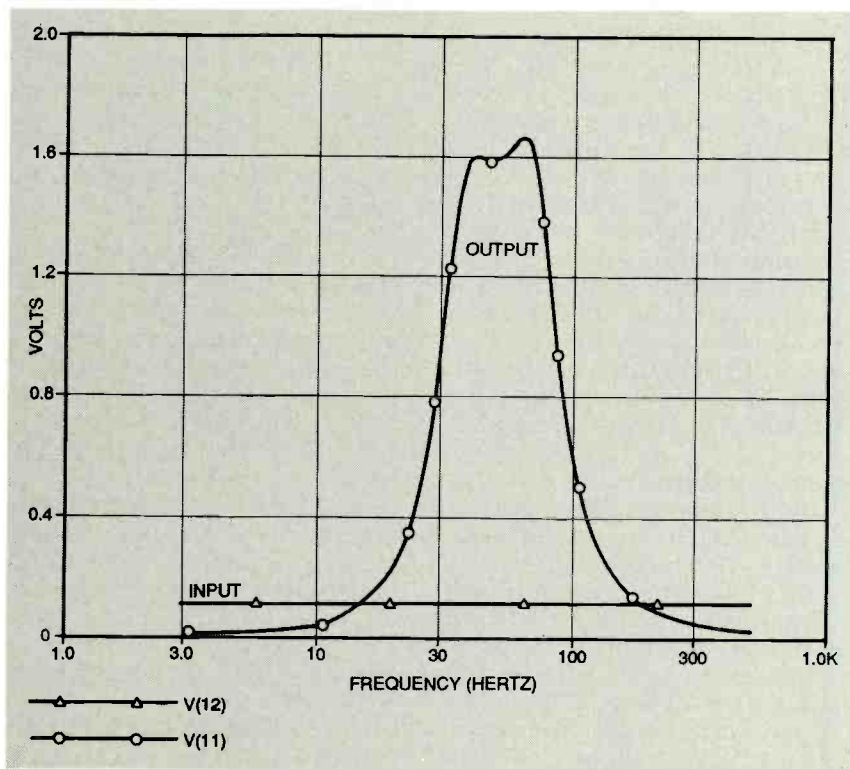


FIG. 2—TWO FILTERS connected back-to-back form a bandpass filter with this transfer function.

beta types specified, the peak power output into an 8-ohm load is  $(30 \times 30 / 8) / 2 = 56$  watts RMS. The overall gain of the amplifier is set by resistor R13 and feedback resistor R14. Capacitor C6 provides DC blocking.

### Cabinet design

The enclosure is a critical component of any subwoofer design. The Little Earthquake has a fourth-order bandpass enclosure which was designed with the aid of computer software.

The computer model is based on a 10-inch speaker with the parameters shown in Fig. 3. The maximum excursion of the speaker cone was selected to be  $\pm 1/4$ -inch. For best results, a speaker with similar parameters should be selected. The amplifier and speaker are mounted in a sealed 17- x 14- x 8 1/2-inch compartment, which has a volume of approximately

*Continued on page 79*



**Adding this subwoofer to your car audio system will dramatically improve its bass response and lower its distortion.**

# BUILD THIS SUBWOOFER FOR YOUR CAR

## MARK RUMREICH

WHAT'S THE BEST WAY TO UPGRADE your car stereo? For many systems, replacing poor quality speakers with better ones is the best way to upgrade the sound without spending a lot of money. After that, adding a subwoofer tops the list. A high-quality automotive subwoofer system can be assembled for less than \$150. This article explains how to assemble it.

A subwoofer provides two main advantages: First, it provides a dramatic improvement in bass, and second, it improves the higher frequencies by letting you turn down the bass frequencies that are fed to the other speakers. That lowers distortion and lets you play the other frequencies louder.

After a subwoofer is added, many people are astounded by the clarity of the resulting sound. This occurs because amplifier clipping and speaker excursion "bottoming" during loud passages are eliminated, and no longer distort the upper bass, midrange, and treble. The main amplifier no longer need supply high-power bass to the main speakers.

### Subwoofer strategy

The subwoofer system is composed of three basic compo-

nents: a subwoofer crossover, a power amplifier, and a subwoofer speaker and enclosure. Many subwoofer installations are based on quality subwoofers and power amplifiers, but include poorly designed (cheap) crossovers. The results are boomy bass, poor imaging, high distortion, and noise. The three most important things to look for in a subwoofer crossover are a steep cutoff slope (at least 18 dB per octave), a selectable cutoff frequency, and a subsonic filter.

A steep cutoff slope is important to prevent midrange and upper bass frequencies from reaching the subwoofer. Midrange and upper bass frequencies are *directional* for the human ear, which means that you can detect the direction where the sounds are coming from. Deep bass is *nondirectional*, which means that you

can't determine the direction from which the sounds are coming. Keeping directional frequencies out of the subwoofer is necessary if you want to install the speaker anywhere in the vehicle without degrading the stereo image. It also lets you use a single mono subwoofer rather than separate left and right subwoofers.

Another reason to keep midrange and upper bass out of the subwoofer is to prevent boomy-sounding bass. Only a filter with a steep cutoff slope can effectively eliminate the boomy-sounding upper bass without reducing the desired deep bass frequencies.

Selectable cutoff frequency lets you match the subwoofer to the rest of the system. This prevents a "peak" or "hole" in the combined frequency response. The best way to obtain selectable cutoff frequency is to use a

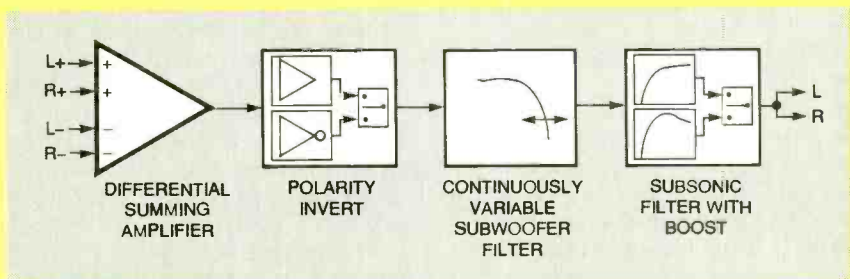


FIG. 1—BLOCK DIAGRAM of the subwoofer crossover. The crossover has a 24 dB per octave cutoff slope and a continuously variable cutoff frequency.

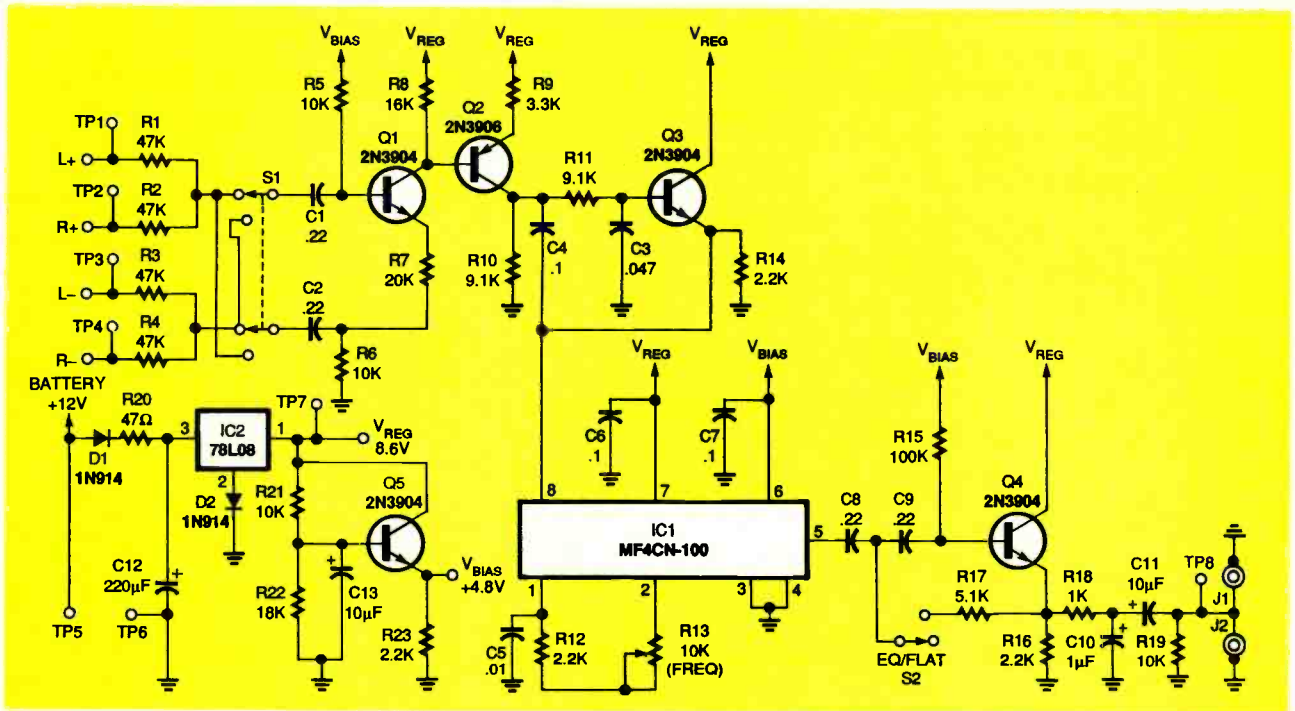


FIG. 2—SCHEMATIC OF THE SUBWOOFER CROSSOVER. Potentiometer R13 controls the cutoff frequency of IC1 by controlling its sampling frequency.

continuously variable filter that lets you fine tune the subwoofer response for the best sound. Then you can tailor it for the vehicle's interior acoustics and mask the low-frequency effects of road noise.

A subsonic filter prevents subaudible energy from reducing dynamic headroom and distorting the bass. It also eliminates annoying turn-on thumps. To be effective without sacrificing the deep-bass response, the subsonic filter should have a slope of at least 12 dB per octave.

### Subwoofer crossover

Figure 1 is the block diagram of the subwoofer crossover. The crossover has the following features:

- 24 dB/octave cutoff slope
- Continuously variable cutoff frequency
- 18 dB/octave subsonic filter,
- Polarity switch
- 40 Hz boost switch
- Speaker level inputs with active ground-loop isolation

The design incorporates a tunable 24 dB per octave Butterworth filter based on switched-capacitor technology. The cutoff frequency is continuously variable from 50 to 150 Hz. The sub-

sonic filter is 18 dB per octave, and has a cutoff frequency of 20 Hz. In addition, the frequency response of the subsonic filter is switchable between a "flat" characteristic and a "boost" characteristic (which provides a 5 dB peak at 40 Hz). This boost can extend low-end response and provide deep bass punch without damaging the woofer.

The subwoofer crossover is engineered to prevent system noise problems. It has a differential amplifier at the front end to provide ground-loop isolation and a precision linear regulator to provide clean power for clean sound. This combination eliminates such problems as alternator whine, blower motor pickup, and ignition noise.

Figure 2 is the schematic for the subwoofer crossover. The inputs through Q1 form a differential summing amplifier with switch S1 functioning as a polarity inverter. A 24 dB per octave switched capacitor filter (IC1) is the heart of the continuously variable filter. Potentiometer R13 controls the cutoff frequency of IC1 by controlling its sampling frequency. Because of the inherent sampling action of switched capacitor fil-

ters, an anti-aliasing filter is required at the input of IC1. Transistors Q2 and Q3, along with the surrounding components, form this second-order, low-pass, anti-aliasing filter.

The subsonic filter with a boost stage follows the output of IC1 at pin 5. When switch S2 is closed, the boost is added. Additional subsonic filtering action is provided by C1 and C2 at the inputs of the crossover circuit. A "reconstruction filter" that eliminates sampling artifacts is formed by R18 and C10 at the output of IC1.

The power-supply circuit, based on the 78L08 voltage regulator IC2, provides both an 8.6-volt main supply and a 4.8-volt bias supply. Diode D1 protects against negative voltage spikes and incorrect hookup. Diode D2 biases the 78L08 regulator reference pin at 0.6 volt to provide an output of 8.6 volts rather than 8 volts.

### Crossover construction

Figure 3 is the parts-placement diagram for the crossover PC board. You can make your own board from the foil pattern provided here, or you can purchase one from the source men-

*Continued on page 84*

## RAY MARSTON

THIS ARTICLE IS ABOUT AC BRIDGES for measuring inductance and capacitance. It explains one popular capacitance bridge and two popular inductance bridges. Included are schematics for building your own AC bridges and modifying them for your requirements in experiments or making precise laboratory-grade measurements. The previous article in this series on bridges explained the basic Wheatstone DC resistance bridge and modifications to that bridge that made it possible to measure both inductance and capacitance.

### Reactance, impedance, and $\theta$

Inductors and capacitors offer resistance to alternating current. In a capacitor, resistance is known as capacitive reactance, and in an inductor it is known as inductive reactance. Reactance depends on frequency, and the capacitor's value farads and the inductor's value in henrys. The equation for capacitive reactance is:

$$X_C = 1/(2\pi fC)$$

The equation for inductive reactance is:

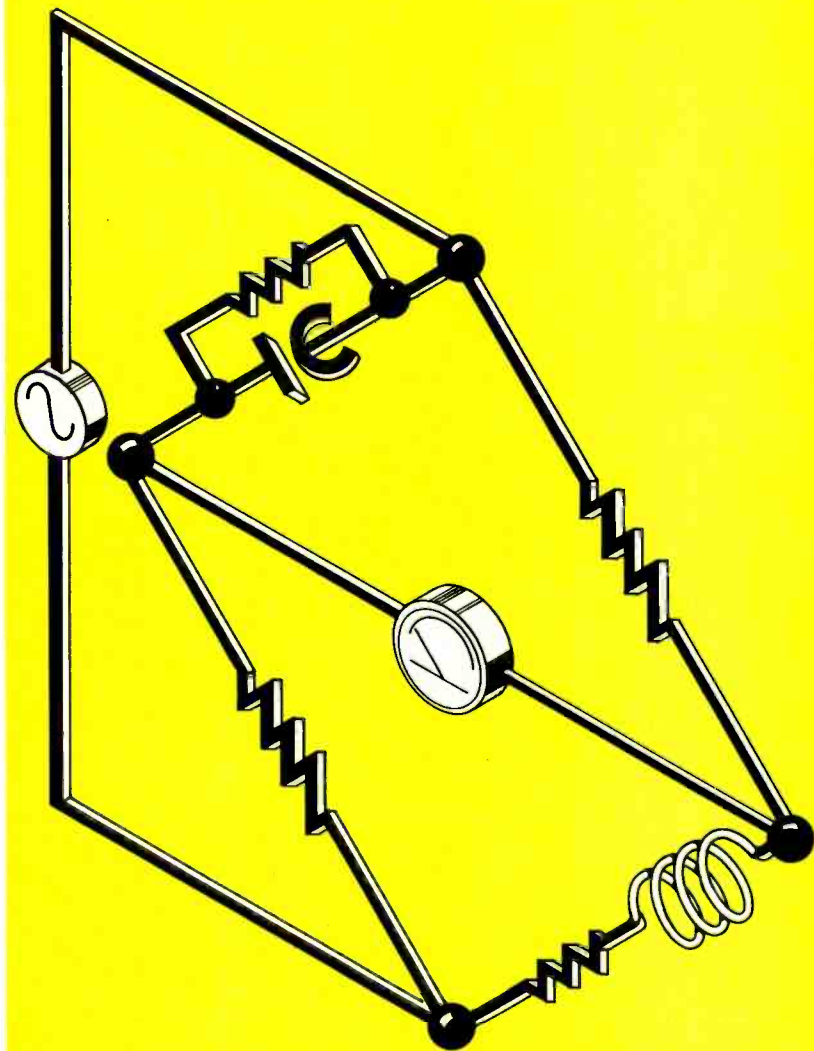
$$X_L = 2\pi fL$$

The term  $2\pi f$  is called *angular frequency* and is represented by the lower-case Greek letter omega ( $\omega$ ).

It is important to remember that neither practical capacitors nor inductors are pure reactances because of the presence of mechanical elements that introduce parasitic inductance and resistance into capacitors and parasitic capacitance and resistance into inductors.

However, the true equivalent circuits for inductors and capacitors can be simplified for accurate measurements of most components used in general applications, but all of these residual effects must be taken into account in measuring some components such as high-value aluminum electrolytic capacitors.

Because of phase relationships in AC circuits, current is seldom in phase with voltage. In a pure capacitor, cur-



## L-C BRIDGES

**Learn about popular capacitance and inductance bridges, and build your own Hay-Maxwell bridge and an 18-range LCR laboratory-grade bridge.**

rent leads voltage by a phase angle of  $90^\circ$ , and in a pure inductive circuit voltage leads current by a phase angle of  $90^\circ$ . Phase angle is designated by the lower case Greek letter theta ( $\theta$ ). These angle relationships change with the introduction of other reactive components.

Impedance is the result of resistance and reactance in an AC circuit. The phase angle  $\theta$  be-

tween the voltage and current can be any angle between  $-90^\circ$  and  $+90^\circ$ .

Impedance in a series circuit is:

$$Z = \sqrt{R^2 + X^2}$$
$$\theta = \tan^{-1} X/R$$

Impedance in a parallel circuit is:

$$Z = RX/\sqrt{R^2 + X^2}$$
$$\theta = \tan^{-1} X/R$$

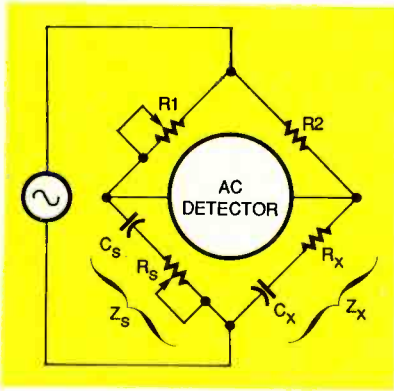


FIG. 1—A SERIES RESISTANCE capacitance bridge

for energy to be released. The  $Q$  of an inductance equals  $X_L/R$ , where  $R$  is the series resistance of the inductance. The  $Q$  of a capacitor equals  $-X_C/R$  (a negative value).

### L and C bridges

Capacitance bridges can make precise measurements of capacitors and their associated loss resistances in terms of a known capacitance and resistance value. There are different bridge circuits capable of making these measurements.

combination of resistances, inductances, and capacitances. One popular capacitance bridge and two popular inductance bridges are discussed later in this article.

### Series RC bridge

The schematic for the series RC bridge is shown as Fig. 1. It is a resistance-ratio bridge that compares a known capacitance with an unknown capacitance. The bridge is balanced when  $R1/Z_S = R1/Z_X$ . Under this condition:

$$C_X = C_S(R1/R2)$$

$$R_X = R_S(R2/R1)$$

$$Q = 1/2\pi f C_X \times R_S$$

The values of  $R1$  and  $R_S$  balance the AC voltages and phase shifts on the detector's left legs with those on its right legs.

Figure 2 is the schematic for a six-range series RC bridge that spans the range of 1 picofarad to 10 microfarads in six decade ranges. About half of the source 1kHz voltage appears at each end of the detector at balance. The AC detector can be either a simple meter or headphones. Table 1 relates the six capacitance ranges switched by  $S1$  with the resistance value in each channel and full-scale impedance value.

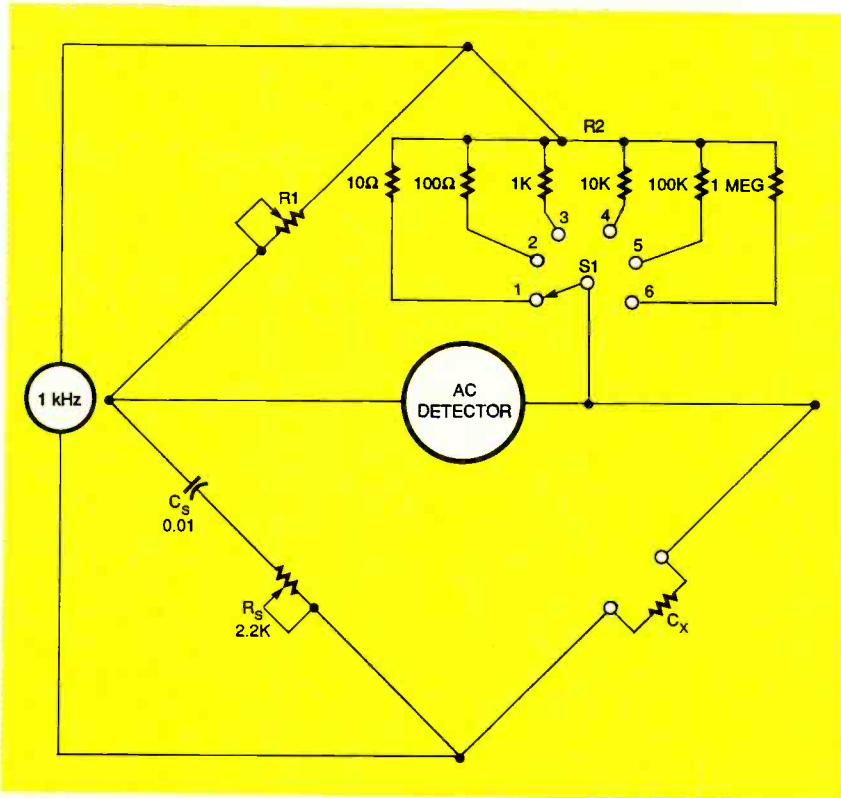


FIG. 2—SIX RANGE SERIES resistance-capacitance bridge.

TABLE 1  
RESISTANCE VS. CAPACITANCE RANGE VALUES  
RESISTANCE-CAPACITANCE BRIDGE

Switch S1 Range	Bridge Range	Resistor R2 Value	$Z_X$ Full Scale $R_S=0$
1	0 - 10 $\mu$ F	10 $\Omega$	15.9 $\Omega$
2	0 - 1.0 $\mu$ F	100 $\Omega$	159 $\Omega$
3	0 - 0.1 $\mu$ F	1.0 K	1.59 K
4	0 - 0.01 $\mu$ F	10 K	15.9 K
5	0 - 1.0 $\mu$ F	100 K	159 K
6	0 - 100 pF	1 MEG	1.59 MEG

The  $Q$  of a capacitor, coil or device is a figure of merit for its energy-storing capability. The higher the  $Q$ , the longer it takes

There are also many different bridge circuits that can measure inductance because the impedance of each arm can be a

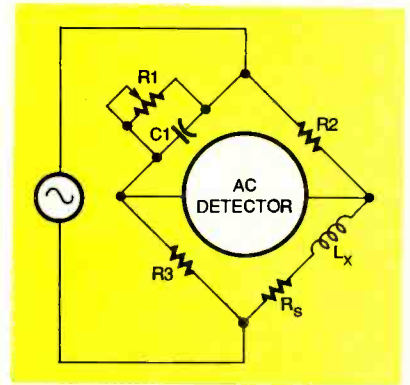
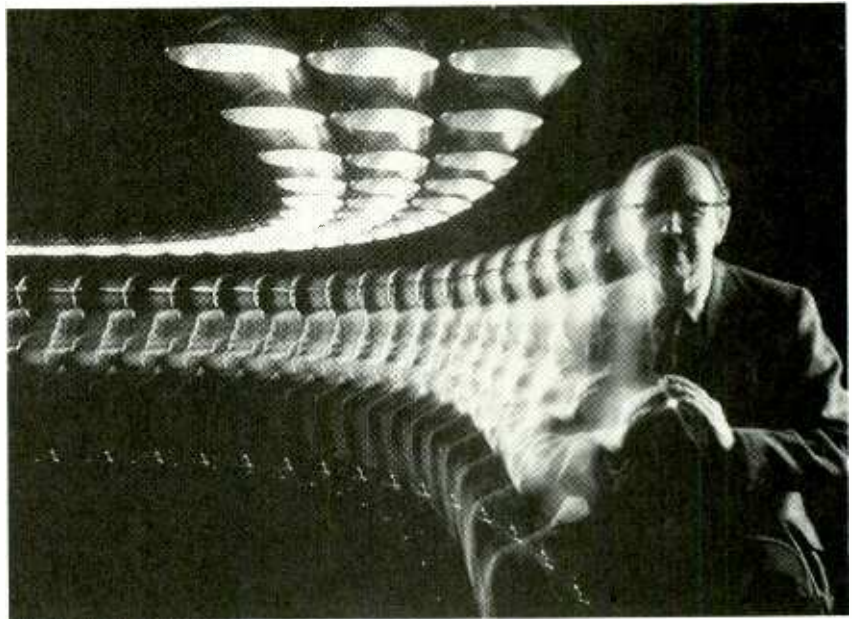


FIG. 3—THE MAXWELL BRIDGE can measure the values of low-Q coils.

Variable resistor  $R_S$  permits a null to be obtained when capacitor  $C_X$  has  $Q$  values as high as 7.2. (Any capacitor with a  $Q$  value that high should be discarded.) The value of potentiometer  $R_S$  can be calibrated directly in  $1/Q$  values because in this circuit with a 1-kHz source,  $1/Q = 0.001$  per 15.9 ohms of

Continued on page 87

**Harold Edgerton was a prolific inventor of stroboscopes, high-intensity lamps, underwater cameras, and specialized sonar. But he is best remembered for his ultra-high-speed photographs that are recognized as works of art.**



# SEEING th<sup>e</sup> UNSEEN

PHILIP CONDAX

AN EXHIBITION AT THE GEORGE Eastman House in Rochester, N.Y. entitled *Seeing the Unseen: Dr. Harold E. Edgerton and the Wonders of Strobe Alley*, offers the public an opportunity to appreciate some of the outstanding contributions to science, engineering and art made by Dr. Edgerton. The exhibit is scheduled to leave Rochester on October 31 to tour five other museums before it ends in San Diego in 1997.

Photography was only one of the many consuming interests of this American engineer, scientist, inventor, and educator whose curiosity and energy led him to improve large synchronous motors and invent high-intensity flashlamps, stroboscopes, special undersea cameras, and exploratory sonar. This Massachusetts Institute of Technology professor, who died in 1990, actually became an artist by accident.

Dr. Edgerton's perfection of the stroboscope made it possi-

ble for engineers to stop the action of moving machines so they could see their faults and correct them, and his methods for "freezing" actions on film that are too fast to be seen by the human eye gave us our first clear pictures of events in the microsecond domain.

While Harold Edgerton might not be a household name, there can scarcely be a person on this planet who has not seen his photographs of a crown formed by a milk drop as it splashes into a saucer or speeding bullets passing through apples and playing cards. Perhaps less memorable, but of great importance to athletes, trainers, and physiologists are Edgerton's multiple-image pictures of a diver's trajectory as he springs off a platform or the fan-like images made by a golf club as the golfer swings to drive a ball.

Edgerton's methods for making those landmark pictures have long since been adopted by others for photographing eggs

dropping, birds in flight, and glass bulbs exploding—to mention but a few of his subjects. His techniques advanced man's knowledge of ultra-high speed motions that occur in nature, science, and engineering. But you have probably also seen those television commercials extolling the benefits of stain-free carpet on floors that have received a cascade of slow-motion food spills. All of those special effects owe a debt to Dr. Edgerton's techniques.

Edgerton's early stop-action photographs were taken, almost reluctantly, from his laboratory to art museums where they are now declared to be images of esthetic beauty. His pioneering work on stroboscopes turned a laboratory curiosity into a practical engineering tool for diagnosing faults in moving machines from electric motors to jet engines, and his flash-tubes have become standard equipment in the camera bags of photographers.

## Home on the plains

Harold Edgerton was born in one small town in Nebraska in 1903, but his family soon moved to another small Nebraska town, Aurora. This move was to have a lasting influence on his philosophy of life and career direction. He credited his successes, in part, to being raised on the Midwestern plains where he learned, early in life, the virtues of hard work and perseverance.

But, of more importance was the power station in this town of less than 4000 people. Aurora was one of the few small towns in Nebraska to be electrified before World War I because wealthy farmers living nearby could

finance and support a power station. As many as 20 years would pass before many of the neighboring rural towns would be electrified.

Edgerton was so fascinated by the power station's generators and transmission equipment that he sought and obtained work there as a janitor and general laborer while attending high school and during college vacations. As luck would have it, a labor shortage during World War I gave him the opportunity to become a lineman, a prestigious occupation, at an early age.

Not surprisingly, that satisfying work experience determined his major at the Universi-

ty of Nebraska—electrical engineering. While still an undergraduate at Nebraska, Edgerton earned an internship at General Electric's research laboratory in Schenectady, New York. After graduation from Nebraska in 1925, he continued to work at the GE lab before deciding to start graduate work at MIT in the fall of 1926.

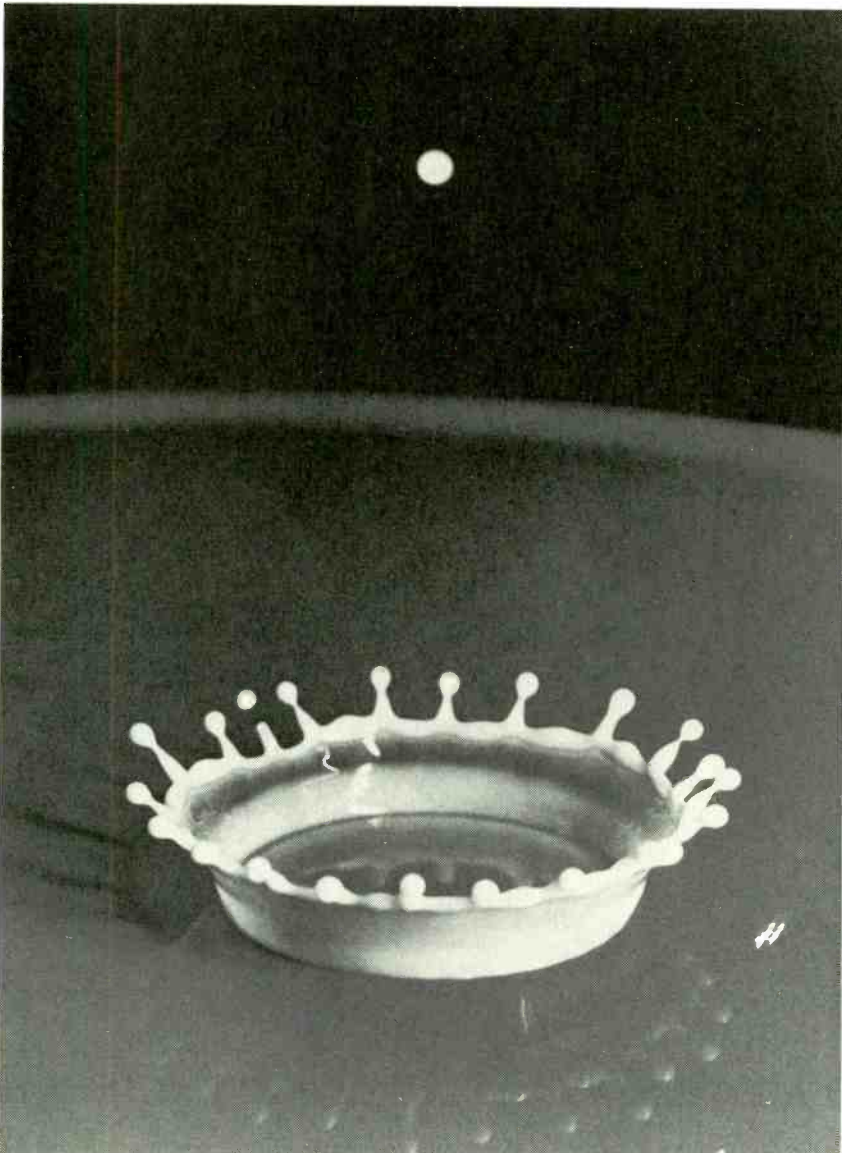
Subjects that had intrigued him while working at the power company influenced his choice of research projects as an MIT graduate student. He sought to improve the efficiency of large industrial and utility synchronous motors. Both his master of science and doctor of science theses were on the mechanical and electrical shortcomings of those large motors and his recommendations for improving them. He received his master's degree in 1927 and his doctoral degree in 1931 from MIT, both in the field of electrical engineering.

While testing a motor in what was then called the Dynamo Lab at MIT, Edgerton noticed that the motor's armature appeared to be standing still when viewed in the flashing light from a firing thyatron tube. That observation was the start of his association with the stroboscope, a scientific instrument that could "stop" the actions of moving machines.

The armature of the motor was turning at hundreds of revolutions per minute, but in the flashing light from the thyatron it appeared to be stopped. He was able to see what was occurring in the motor under load conditions because of the *stroboscopic effect* made possible by human *persistence of vision*. Far more economical and efficient than taking motion pictures of the moving motor, the strobe effect made it possible for him to analyze motor faults as they occurred and correct them while standing there.

The human eye-brain response is too slow to react individually to two separate images that reach the eye within less than one-tenth of a second.

*Continued on page 90*



THE MILK DROP CORONET, the famous photo of a drop of milk falling into a shallow dish.



# Understanding Pitot tubes.

*Plus a GPS navigation update, picking a new microcontroller, new Internet directories, and more on the mystery band.*

**M**AYBE IT'S BECAUSE I AM SITTING HERE ON A SAND DUNE WATCHING GILA MONSTERS IN THE MIDDLE OF THE UPPER SONORAN DESERT, BUT NOBODY HAS EVER ACCUSED ME OF BEING

much of a boat person—at least not lately. I do know that the binnacle goes on the top and the barnacle goes on the bottom. Interchange those two and you end up with a serious breach of maritime etiquette. At any rate, one recent help-line caller wanted to find out if I knew anything about how boat speedometers operate.

## Boat speedometers

Not having the faintest idea at the time, I muttered several things about gyros, strain gauges, differential thermistor temperature sensing, GPS, and sonic Doppler radar shifts. Most of which were wrong.

Let me review the normal ways of finding an answer to something I do not have the foggiest clue about: Ask some expert or visit a suitable place where I can find an answer. In this case, that would be a marina or a boating supply store. Read relevant magazines and trade journals, such as those on boating or on marine retailing, and even boating-supply catalogs. Then contact the manufacturers for useful literature. Most important, seek out relevant reference papers.

Another option is to search the Internet or a commercial online service. You can also try a surefire

solution that lets you instantly find *any* answer to *any* technical question: Use the *Dialog Information Service* found at your local library or conveniently online at *GENie*. If there's no real rush, try my ultimate ploy: let your subconscious work on the project for a few weeks until you stumble over an answer.

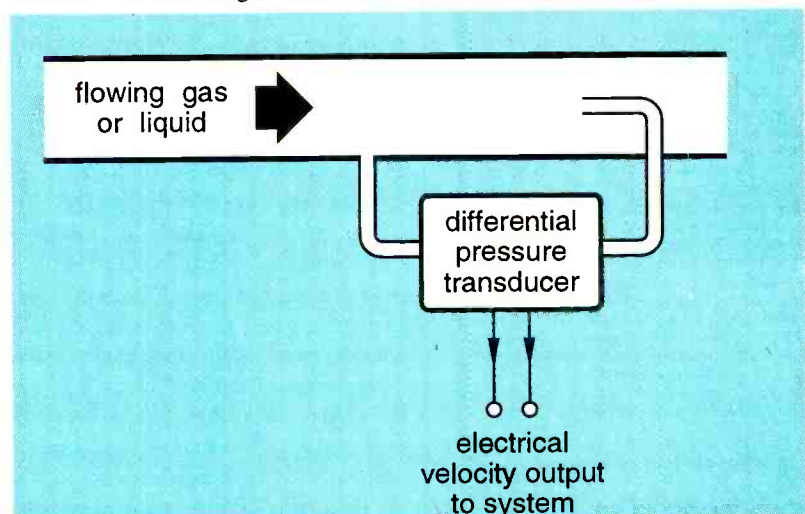
Sure enough, *Motorola* sent me a new *IC Sensor Device Data* manual. And right there on page 4-166 is application note AN1536 on, of all things, boat speedometers, including the full construction plans. There's also one magic word that

tells us all about how boat speedometers work: *Pitot*.

That tells us that boat speedometers work exactly the same way that airplane speedometers operate. Only one uses a liquid, and the other a gas.

Pitot tubes were first developed by Henri Pitot, an eighteenth century French physicist. Figure 1 shows details. Create a smooth flowing and non-turbulent liquid or gas channel of constant diameter, such as a pipe. Measure the *differential* pressure between a radial and an axial port. The pressure difference should be nearly proportional to the *square* of the velocity, usually within five or ten percent.

The exact results depend on the density of the liquid or gas and the temperature. Figure 2 shows the curves for freshwater and saltwater boat speedometer pressures. The



**FIG. 1**—A PITOT TUBE can be used to measure the velocity of a flowing liquid or gas. Uses include boat speedometers and fire hydrant testers.

speed will, of course, be that of the boat *relative* to the water current.

Motorola has a unique offset-canceling scheme which swaps the op-amps around and then cancels out the difference so that the speedometer can show absolute speed instead of relative speed. Other low cost pressure transducer sources are available from *Sensym*, *IC Sensors*, and *NovaSensor*.

Pitot tubes are not suitable for sailboats or other low-speed applications. Other techniques are required for ultra low velocities. Differential GPS is an obvious choice.

Ah, hindsight. After thinking about it for a while, it seems I do use a boat speedometer quite a bit after all. Except that its box is plainly labeled "Fire Hydrant Flow Tester." All fire hydrants must be tested twice each year. First to make certain they work at all, and second to verify a peak fire flow gallonage rate that can meet a given insurance rating class.

You hold this beast in the middle of an open hydrant stream and grab a reading. Then you look up the flow in

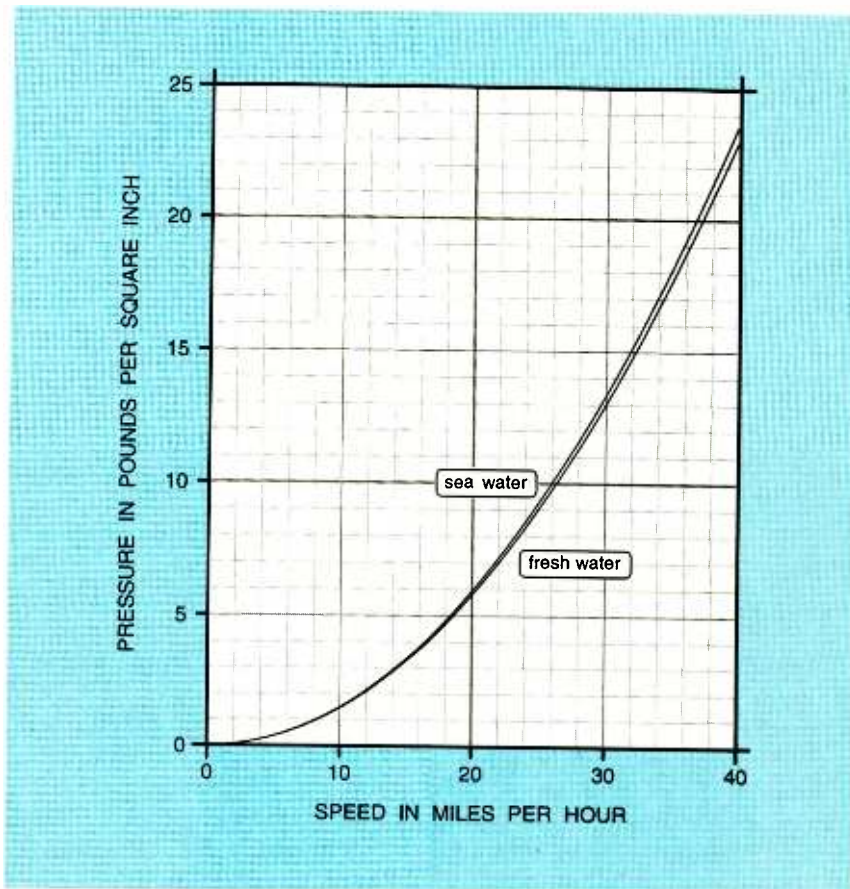


FIG. 2—PRESSURE VERSUS SPEED for flowing water at 60 degrees F.

a graph remarkably similar to the curves of Fig. 2.

I still don't have any information on commercial versions of boat speedometers. So, how about sending me some data sheets on them. There's a free *Incredible Secret Money Machine II* for your trouble.

### Controllers

What is the difference between a microprocessor, a microcontroller, and a digital signal processing chip? Why would you select one of those devices over either of the others?

Before you can find the answers to those questions, you should first look into a concept called *address space*. Figure 3 shows some details. The address space is the sum total "reach" of a programmable IC. As in a city directory, an address space has *locations*. Into each location, you can put one "unit" of information.

This unit of information is often called a *byte*. Any given byte can be a computer command, one piece of data, one character in a document, a

musical note, or an I/O "window" to the outside world. Bytes are eight bits in length. One byte is capable of representing as many as 256 different values. Multiple bytes can be combined for additional values.

The hardware located in any particular address space location is often RAM, ROM, I/O, or nothing. RAM is any memory that is fast and easy to change. ROM is any memory that stays more or less permanent, even on power-down. These days, of course, RAM is becoming very ROM-like, and vice-versa. There is a continuum of intelligently chosen options here.

I/O is short for *input* or *output*, and is the way your computer circuitry can reach the outside world. And finally, not all of the address space must actually be used. Some of it could be empty; other portions can be available but not in use.

The size of the address space can be as little as 256 bytes in certain controllers. A classic 8-bit microcomputer has an address space of 64K, or 65536 locations. Newer chips have

**NEW FROM  
DON LANCASTER**

<b>HARDWARE CLASSICS</b>	
Incredible Secret Money Machine II	18.50
The Case Against Patents	28.50
Hardware Hacker Reprints II, III, or IV	24.50
Blatant Opportunist Reprints	24.50
Resource Bin Reprints	24.50
Ask The Guru Reprints I, II or III	24.50
CMOS Cookbook	28.50
TTL Cookbook	28.50
Active Filter Cookbook	28.50
Micro Cookbook I	19.50
Lancaster Classics Library	119.50
<b>POSTSCRIPT STUFF</b>	
PostScript Secrets (He/Mac/PC)	29.50
Book-on-demand resource kit	39.50
Intro to PostScript VHS Video	29.50
PostScript Beginner Stuff	29.50
PostScript Show & Tell	29.50
PostScript Cookbook (Adobe)	19.50
PostScript Ref. Manual II (Adobe)	32.50
PostScript Program Design (Adobe)	24.50
Type I Font Format (Adobe)	16.50
Acrobat Reference (Adobe)	24.50
LaserWriter Reference (Apple)	19.50
PostScript by Example (McGilton)	29.50
Pgm Display PostScript with X	29.50
PostScript Visual Approach (Smith)	22.50
Thinking in PostScript (Reid)	22.50
Undst PS Pgrmmg (Holtzgang)	29.50
The Whole Works (all PostScript)	379.50

FREE VOICE HELPLINE      VISA/MC

**SYNERGETICS**  
Box 809-RE  
Thatcher, AZ 85552  
(520) 428-4073

CIRCLE 205 ON FREE INFORMATION CARD

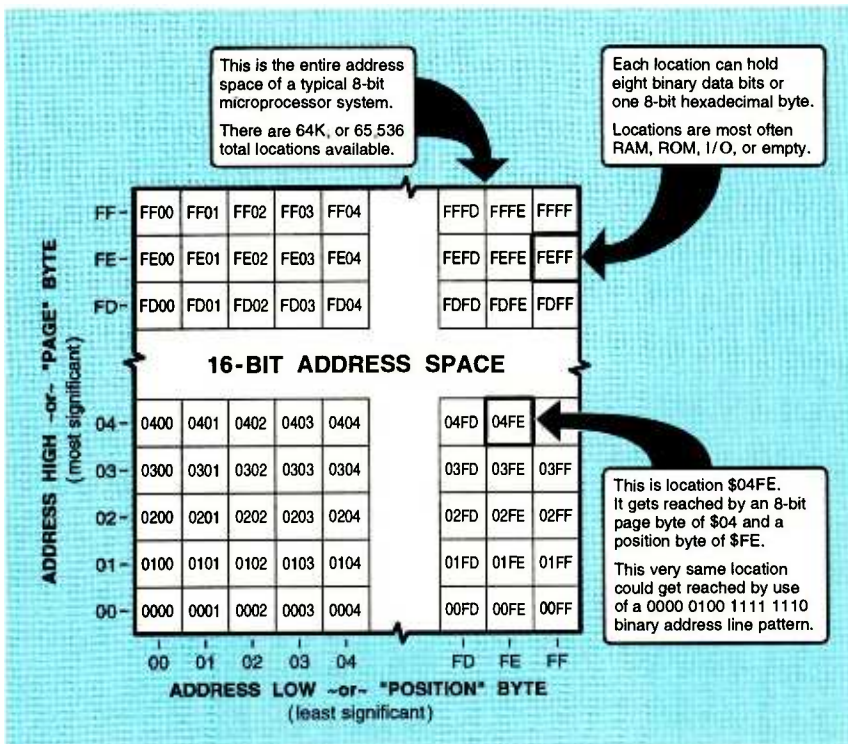


FIG. 3—THE ADDRESS SPACE of a classic microprocessor.

address spaces of 24 bits (for a grand total of 16,777,216 locations), or 32 bits (for a vast 4,294,967,296 possible locations).

The big tradeoff between microprocessors and microcontrollers is chip count. A microcontroller with internal-only address space often allows your design to get by with a single integrated circuit. But the RAM and ROM provided is both fixed and restricted. An external address space lets you add nearly anything you want. Almost any way you like, for much greater flexibility and performance at higher system cost.

Some single-chip solutions let you have the best of both worlds. While their address space stays fixed and internal, they easily let you add low-cost *serial* memory chips for extra data storage and whatever. Although serial memory is much slower than memory inside the "real" address space, it is more than fast enough for many real-world applications. Figure 4 summarizes the key differences between these main three computing options.

A *microprocessor* normally has a large address space, a generalized instruction set, and requires additional chips for a complete system. A *microcontroller* normally has a small

internal address space, and its instruction set is optimized for control and other bit manipulations. Microcontrollers usually provide a single-chip solution. A *digital signal processor* (or DSP) is just a different name for a microprocessor, except that it uses fewer, more specialized commands.

The instructions for a DSP chip are carefully optimized for digital filter uses and related tasks, and thus aren't all that great for anything else. The specialized DSP instructions might include an ultra fast multiplier, a multiplier/accumulator that adds a small value to a large total, or some *barrel shifter* that instantly multiplies or divides by powers of two.

#### NEED HELP?

Phone or write all your Tech Musings questions to:

Don Lancaster  
Synergetics  
Box 809-EN  
Thatcher, AZ, 85552  
(520) 428-4073

For fast PSRT access, modem (800) 638-8369. On prompt, type JOINGENIE. When asked for the offer code, enter DMD524.

US Internet email access link: SYNERGETICS@GENIE.GEIS.COM.

There are certain things that DSP chips do very well. But their highly specialized nature and their military heritage has kept them expensive and out of the mainstream. Sadly, DSP program development and emulation remain as costly hassles. But DSP popularity is very much on the upswing, especially for applications in sound generation, fancy filters, and video compressors.

By far the finest choice in any microcontroller today is the PIC from *Microchip Technology*. The best way to get started using microcontrollers is with the *Basic Stamp* from *Parallax* and the *Scott Edwards Tools* for full machine code access and speed.

By special arrangement, I've made the complete Basic Stamp manuals available on my *Genie* PSRT. See BASTAMP1.PDF for the intro, BASTAMP2.PDF for the instruction set, and BASTAMP4.PDF for updated and expanded applications.

#### Microcontroller resources

The usual places to start learning about microcontrollers are the hobby press publications and in the mainstream electronic trade journals. But there are a bunch of virtually unknown "second tier" trade journals that focus on topics of interest to microcontroller designers. I thought I'd gather a few of these together for this month's resource sidebar.

#### GPS update

Prices are coming down fast and furious on the GPS navigation front. I'd expect a \$190 device from *Radio Shack* about the time you're reading this. Probably somewhat comparable to a *Garmin 45* receiver.

What everybody is waiting for, of course, is a full set of topographical maps built into a \$99 handheld GPS device with an instant and high resolution "you are here" full-color 3-D display.

Some surprising giant steps have been taken toward that goal. One Israeli machine lets you slide a topographical map inside it, and then it can X-Y plot your current position and track for you. It is, however, way overpriced and clearly the device needs improvement.

## OBSCURE MICROCONTROLLER PUBLICATIONS

### AI Expert

600 Harrison Street  
San Francisco CA 94107  
(415) 905-2200

### C++ Report

71 West 23rd Street 3rd Floor  
New York NY 10010  
(212) 785-5996

### CADence

600 Harrison Street  
San Francisco CA 94107  
(415) 905-2200

### Compliance Engineering

One Tech Drive Ste 215  
Andover MA 01810  
(508) 264-4208

### Computer-Aided Engineering

1100 Superior Avenue  
Cleveland OH 44114  
(216) 696-7000

### Dr Dobb's Journal

411 Borel Ave #100  
San Mateo CA 94402  
(415) 358-9500

### DSP & Multimedia Technology

PO Box 1603  
Los Altos CA 94023  
(415) 969-6920

### Embedded Sys Programming

600 Harrison Street  
San Francisco, CA 94107  
(415) 905-2200

### Forth Dimensions

PO Box 2154  
Oakland CA 94621  
(510) 525-1295

### IC Card Systems & Design

6300 S Syracuse Way, #650  
Englewood CO 80111  
(303) 220-0600

### Integrated System Design

5150 El Camino Real Ste D31  
Los Altos CA 94022  
(415) 903-0140

### Microsoft Systems Journal

411 Borel Avenue Ste 100  
San Mateo CA 94402  
(415) 358-9500

### Personal Engineering

Box 430  
Rye NH 03870  
(603) 427-1377

### Surface Mount Technology

17730 W Peterson Road  
Libertyville IL 60048  
(708) 362-8711

The brand new *ScoutMaster* from Trimble knows an even handier trick: Besides telling you how fast you are hiking, it will tell you where you are on which topographical map!

Inside the machine is a database of 53,689 USGS (United States Geological Survey) topographical maps in their 7-1/2 minute or "seven by nine mile" size. Not the entire map, of course, but the map name and the latitude-longitude for enough key points to give you the nearest 2-1/2-minute reference point. That is *one-ninth* of the map, or well inside a three-mile square.

The readout then displays your *scaled map distance* away from one of these reference points. Say an inch and a half west and three quarters of an inch north. That sure beats messing around with latitude and longitude. The usual "on the run" accuracy of a single GPS measurement on most single low-end receivers is only 300 feet or so. By changing to *differential* GPS techniques, you can drop this down into the twenty-foot range. By going to multiple stations and longer term measurements that need premium multi-frequency receivers, you can actually achieve a "surveyor" accuracy of one centimeter—anywhere in the world.

Here is how the differential GPS works: You start with *two* receivers, and place one at a fixed and known location. Let it record where it thinks it is, and you can determine the error because you know where it really is. Then make your real measurement with the moving receiver, and then subtract out the error difference. Since these errors are pretty much the same over some thirty miles or so, there are now pager services and commercial FM broadcast subcarriers that will transmit these GPS corrections for you in real time.

A *differential ready* handheld GPS receiver simply has a jack on the side that accepts the correction data in a standard format. Plug in a suitable service and your location accuracy can improve dramatically.

One GPS trick that newcomers do not pick up on: You can easily fake the differential results. Simply use a second and fixed position receiver and

then manually or automatically record the time and the error. Then take the error out during the final plotting. The closer you can get the two readings in time, the better your final overall accuracy.

I am using GPS on a historical archeology project I have going on the utterly astounding aerial lumber tram that's literally in my front yard. See my *Blatant Opportunist* reprints or GRAMTRAM.PDF on *GENic* PSRT for more details. Yeah, I could use some help on some of the more gruesome portions of the terrain on this project.

One good source of GPS receivers, books, and tutorials is *Navtech*. They resell the Garmin and ScoutMaster receivers, and many others. The "horse's mouth" tutorial documents are provided by the *Institute of Navigation*.

The main source for FM services is *Differential Corrections*. The leading trade journal is *GPS World*, which publishes a *GPS Showcase* shopper.

### A New Internet directory

While not well known, the three leading suppliers of library reference directories are: *Bowker*, *Oxbridge*, and *Gale Research*. That's where such resources as *Books in Print*, *Ulrich's Periodicals Dictionary*, the *Encyclopedia of Associations*, and related goodies come from.

Sadly, these valuable directories are too pricey for most individuals, besides being unloanable references at most libraries. Many are, however, newly available both online and as CD-ROM based products.

There is one brand new \$95 *Gale Guide to Internet Data Bases* which should turn into a major and highly useful printed Internet directory. The Internet has been defined by some as a humongous library without shelves, librarians, reference numbers, or card catalogs—in front of which numerous truckloads of new books get dumped daily, and from which lots of other texts vanish without a trace.

Two random selections here: #710

## NAMES AND NUMBERS

### Boardwatch

8500 W Bowles Avenue #210  
Littleton CO 80123  
(303) 973-6038

### RR Bowker

121 Chanlon Rd  
New Providence NJ 07974  
(908) 464-6800

### Dialog Information Services

3460 Hillview Ave  
Palo Alto CA 94304  
(415) 858-2700

### Die Casting Engineer

9701 W Higgins Road #880  
Rosemont IL 60018  
(708) 292-3600

### Differential Corrections

10121 Miller Ave #201  
Cupertino CA 95014  
(800) 446-0015

### Scott Edwards Electronics

964 Cactus Wren Lane  
Sierra Vista AZ 85635  
(602) 459-4802

### Fastener Technology

3869 Darrow Road Ste 101  
Stow OH 44224  
(216) 686-9544

### Gale Research

835 Penobscot Blvd  
Detroit MI 48226  
(313) 961-2242

### Garmin

9875 Widmer Road  
Oenexa KS 66215  
(800) 800-1020

### GENie

401 North Washington St  
Rockville MD 20850  
(800) 638-9636

### GPS World

859 Willamette St  
Eugene OR 97440  
(503) 343-1200

### Institute of Navigation

1800 Diagonal Rd #480  
Alexandria VA 22314  
(703) 683-7101

### Internet World

11 Ferry Lane West  
Westport CT 06880  
(203) 226-6967

### Lattice Semiconductor

5555 NE Moore Ct  
Hillsboro OR 97124  
(503) 681-0118

### Microchip Technology

2355 W Chandler Blvd  
Chandler AZ 85224  
(602) 963-7373

### Motorola

5005 E McDowell Rd  
Phoenix AZ 85008  
(800) 521-6274

### Navtech Info Services

2775 S Quincy St #610  
Arlington VA 22206  
(800) NAV-0885

### Oxbridge

150 5th Ave #202  
New York NY 10011  
(212) 741-0231

### Parallax

3805 Atherton Rd, #102  
Rocklin CA 95765  
(916) 624-8333

### Sony Semiconductor

10833 Valley View St  
Cypress CA 90630  
(714) 220-9100

### Texas Instruments

PO Box 809066  
Dallas TX 75380  
(800) 336-5236

### Trimble Navigation

585 N Mary Ave  
Sunnyvale CA 94086  
(800) TRI-MBLE

*Gargoyles Then and Now* and #629 *Fact and Fiction About Armadillos*. The current directory contains around 2000 data bases and 8000 individual files. I would expect future editions to expand this greatly.

Two other useful Internet guides include *Boardwatch* and *Internet World* magazines. The quickest and easiest way to gain Internet access these days

is by way of some commercial online service such as *America Online*, *GENie*, or *CompuServe*.

### New tech lit

Lots of exciting things are happening in that *mystery band* we looked at a while back. Start off with *Tuning up an Electromagnetic Accordion in Science* for March 24, 1995. Terahertz waves

## O & A

*continued from page 12*

base because when the base is made high, the collector-emitter junction essentially becomes a short circuit and the output at the collector goes low.

If you want the output to follow the sense of the input, put the resistor between the emitter and ground as shown in the figure. When you trigger the base, the output from the transistor will be high.

Notice that by using appropriate resistors between both the collector and the positive supply rail and between the emitter and ground, you can pick off any voltage you need when the transistor is triggered. The exact values of the resistors depend on the voltage you want at the output.

## Degaussing Coil

*I would like to build a demagnetizer for TVs. What type of wire should I use and what specifications should I follow?—C. P., El Monte, CA*

A degaussing coil (demagnetizing coil) is what you use to fix a color picture tube that shows patches of poor color in fixed locations on the screen. The discolored patches are caused by magnetization of the shadow mask, a metal grid just inside the CRT.

Many TVs and computer monitors have a degaussing coil built in which is activated for a few seconds every time you turn the equipment on. To degauss a TV of this type, just turn it on, wait 30 seconds, turn it off, wait 30 seconds, turn it on again, and so on, four or five times.

If that's not sufficient, you'll need a source of an alternating magnetic field. To make a degaussing coil, wind 200 turns (4 pounds) of No. 20 magnet wire into a ring 1 foot in diameter, then wrap the whole thing in electrical tape and add a power cord to plug into the 120-volt AC line.

Turn on the TV or monitor so you can judge the strength of the magnetic field. Hold the degausser several feet away from the screen and turn it

*Continued on page 52*

Most **MICROPROCESSOR** chips have a large and external address space. Into which you place your choice of additional RAM, ROM, I/O or nothing. The instruction set is a general one, often optimized for file manipulation and complex computing tasks.

Instead, a **MICROCONTROLLER** offers a single chip solution with a smaller and fixed internal address space. All resources are defined on chip, with the possible exception of some slower and serial EEPROM memory. The usual instruction set has additional commands in it that favor simple I/O tasks. Such as bit sets, clears, or tests.

Finally, a **DIGITAL SIGNAL PROCESSOR** also usually has a large and an externally accessible address space. But its instruction set is often strictly limited to specialized tasks. Such as a very rapid multiplier, one or more adder/accumulators, or a barrel shifter.

FIG. 4—WHICH COMPUTER CHIP TO USE?

are generated by generating much lower frequency microwaves in a plasma and then by blasting that plasma with a laser, squashing the wave!

The sudden compression magically upconverts the output frequency. It's sort of a mega *Doppler* effect resulting in coherent, tunable, and high power terahertz waves.

It looks as if mystery-band transmissions are going to be called *T-Rays*. See *Science* for June 23, 1995 for the second brand new method of T-ray generation. In this scheme, ultrashort laser pulses are blasted at a suitably blackened array of tiny dipoles. The light becomes an energy impulse that "rings" the dipoles at the correct frequency, opening a whole new world of imaging tools.

You can expect lots of exciting new developments where these came from. The T-band is an incredibly large chunk of spectrum up for grabs.

Sony has a new *CCD Area Sensor* data book. There's a *Lattice Data Book* covering programmable logic chips and development tools. Two unusual trade journals include *Die Casting Engineer* and *Fastener Technology*. *Texas Instruments* has free samples of its TPS2013 high side power control switches.

The old *HP-GL/2 Reference Guide* from *Addison-Wesley* gives you full details on the innards of the *Hewlett Packard* plotter language. The HPGL

is an older and simpler ASCII character based format. It includes such commands as PD for *pen down*, and so on. It has no intelligence, and woefully limited font capabilities.

There's lots of interest these days in converting HPGL from or to that infinitely more versatile, powerful, and flexible PostScript language. See PS2VECT.PS and FLUTOOLS.PS for lots more details.

For those fundamentals of creating your very own technical venture, try my *Incredible Secret Money Machine II*. And we just got a great heaping new shipment of *Active Filter Cookbooks*. These are now self published by my *Synergetics Press*, and are often *not* available locally.

Yes, all new resellers are certainly welcome. Distribution is one of the major hassles of self publishing. See my *Book-on-demand Resource Kit* for more insider information.

Instant help answers, preprints and reprints of most of my stories, and all referenced files are available in my *GENIE* PSRT. I've managed to wrangle a special ten free hour signup for *Electronics Now* readers. See the *Need Help?* box for additional details.

A reminder here that most of the mentioned resources appear either in the *Microcontroller Resources* or the *Names & Numbers* sidebars. Be sure to check here first before calling our no-charge technical helpline. **EN**

on. Bring it slowly up to the screen, just close enough to scramble part of the image. If it's too close and too strong, it can bend the shadow mask, ruining it permanently.

Move the degasser around so that the whole screen gets demagnetized. Then take it far away from the screen before you turn it off. At the moment you cut power to it, there will be a strong burst of magnetism which can magnetize nearby objects.

## PC Thermometer

*I would like to interface a thermometer to my PC. Should I use an A/D circuit reading an amplified thermocouple, or a temperature chip of some type? I'd like to be able to do this for \$20 or less if possible.—J. McCormick, Salem, OR*

Just connect a thermistor across pins 1 and 3 of your joystick port (game port), and read it with the BASIC statement:

R = STICK(0)

which will give an approximate resistance in kilohms. Radio Shack's 10K thermistor will do, but for best results, use a 100K thermistor in series with a 68K resistor. Then you can compute the temperature by doing something like this:

R = STICK(0)

P = 4000

Q = 45

TEMP = P/R + Q

Here P and Q are numbers you'll have to adjust by trial and error. You can use two cups of water, one hot and one cold, with thermometers in them, for calibration. For more information, including software, see *PC Techniques*, April-May 1994, pp. 34 to 38.

The high-tech solution is to use a Dallas Semiconductor DS1620 digital thermometer connected to your parallel printer port. We published an equipment report on Dallas Semiconductor's development kit for the DS1620 back in the March 1994 issue of *Electronics Now*. **EN**

# High-Definition Compatible Digital Processing.

I BECAME AWARE OF THE LATEST AUDIO-  
PHILE LOVE OBJECT IN, OF ALL PLACES,  
THE BUSINESS PAGES OF *THE NEW YORK TIMES*. IT  
APPEARED UNDER THE CATCHY HEADLINE "HOT NEW

Audio Technology Chases Dolby's Soundprints." Once into the article you realized that the only relationship that the "hot new technology" (High Definition Compatible Digital Processing) has with Dolby is the intention of its producers (Pacific Microsonics) to emulate their notion of Dolby's original marketing approach. However, Microsonics has it wrong; Ray Dolby did not start out by selling small numbers of professional encoders and large numbers of consumer decoding chips—but that's another story.

Here's what I learned from the *Times* article: HDCD, which has audiophile hearts all aflutter, is (like Dolby A, B, C, etc.) a two-step process. An HDCD encoder/converter replaces the conventional analog-to-digital converter in the recording studio, and an HDCD decoder chip is installed right before the D/A output circuitry in the home player. An essential difference between the two-step HDCD processing and schemes such as Dolby and dbx is that HDCD-encoded CDs are said to not only be compatible, but to have improved sound even when played back undecoded on

conventional players. HDCD players are also claimed to make conventional CDs sound better through the superior quality of their circuitry.

The virtually universal endorsement given to HDCD by the audiophile press and high-end manufacturers and engineers includes the typical audiophile blather about broader sound stages, greater depth, improved detail, air, ambiance, and so forth. The *Times* article claims that the encoder being shipped to record-

ing studios in June "captures aural information ordinarily missed by digital recordings and reduces noise and distortion. The process also squeezes additional sonic data into little-used bits in the code." All this achieves "recordings that are at least equal in resolution and freedom from distortion to the finest analog master tapes." In other words, digital is now finally as good as analog! The audio millennium is upon us!

I consulted with some audiophile friends who stay on top of such matters (but who are nevertheless quite rational) and I was, I must admit, somewhat surprised to learn that HDCD was neither harebrained nor a scam. I was told that one of the designers, Keith Johnson, was a brilliant recording engineer in addition to being a



PACIFIC MICROSONICS' HDCD ENCODER converts an analog audio signal into a digital signal having a word length longer than 16 bits and a sampling frequency higher than 44.1 kHz.

top-notch audio equipment designer, and his partner, Michael Pflaumer, is well-known and respected in the computer networking systems field.

### Technical description

Pacific Microsonics' technical description of the process goes something like this: In the recording studio the analog audio signal is fed to the HDCD encoder, which converts it into a digital signal having a word length longer than 16 bits and a sampling frequency higher than 44.1 kHz. Since this digital signal has more data than a standard compact disc can handle, "a continuous real-time analysis of the high-resolution signal is made using DSP techniques to determine what elements beyond the range of a conventional compact disc are perceptually important." In other words, which aspects of the improved signal are audible.

The extracted high-resolution data is snuck into the 16-bit, 44.1-kHz CD standard using two methods. Part is added directly to the standard signal by "optimizing utilization of its linear bits" (a.k.a. data compression?) and part is encoded into a control channel also within the standard signal. When a CD embodying the modified digital signal with the added high-resolution signal components is played on a standard CD player, the additional information is said to somehow provide a clear improvement in fidelity over a conventional CD.

But to take full advantage of the HDCD process an HDCD player is required. The encoded signal then gets the full treatment with the information in the hidden control signal directing the decoding function to precisely reconstruct the complete high-resolution signal for the HDCD player's 20-bit, 8×oversampling DAC.

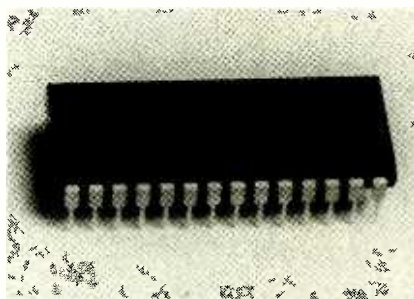
In other words, the recording studio uses an HDCD encoder to extract and save those elements of the signal that are lost in the normal digital recording process. (There's a strong implication that it is those lost parts that make CDs sound inferior to LPs.) Some of the saved signal components benefit an HDCD disc in conventional play; full recovery of the

normally lost signals occurs during playback through an HDCD-equipped recorder.

### Cavils and carps

My problem with all of the above comes down to two questions: (1) Does the CD format really have something inherently and substantially wrong with it?, and (2) Can HDCD fix it? If the first question gets a "no," then the second question is pointless. Microsonics claims that "there is a growing consensus among both recording industry professionals and audiophiles that the existing compact disc format doesn't contain enough amplitude or frequency information to be musically accurate." It seems to me that here we have a claim that is testable both by instrument and subjective double-blind evaluation.

Pacific Microsonics does tell of playing an analog master tape through a highly regarded, industry standard 44.1 kHz, 16-bit record/play chain. The result, as related in their press release, was dramatic: "compared to the original analog source, the digital sound was dull, closed in, and harsh." I find it strange that such an apparently convincing and easily duplicated experiment has not been



AN HDCD DECODER CHIP in a home player will decode the "hidden" music.

repeatedly demonstrated to objective listeners and/or presented as an AES technical paper.

### The bottom line

So what's my tentative final word on HDCD? It should be clear that I approach the format with a somewhat negative bias, if only because of its high-end audiophile perspectives and language. I suspect that the process has technical merit, but its real-world audible virtues may be acoustically

minuscule. A friend who has listened to the same excellent Keith Johnson recordings with and without HDCD processing tells me that everything sounds superb, but that he hears no consistent difference in favor of HDCD. Perhaps HDCD processing is like audiophile cables—you need to believe in the product before you hear the improvement.

At the time of writing, there are perhaps 40 quite pricey audiophile models of HDCD players and about 20 HDCD discs available to feed them. Will the band wagon take off? Historically, major record companies have been loath to spend money on processes that (1) they didn't invent themselves, and (2) won't have a worthwhile financial payoff. To put it bluntly, they are not in it for the fidelity!

Will the record companies see HDCD as a cash cow, or even a calf? I doubt it, since their focus is on the mass music market, which has never demonstrated its concern for nuances of fidelity. The success of CDs over cassettes and LPs does not rebut my point. CDs made it because of their superior convenience and noise-free properties, not because they were sonically superior to cassettes. (LPs sound better than cassettes, but the cassettes' convenience won the dollars of the music buyers.)

Will some recording studios install HDCD encoding equipment? Of course, especially if some recording artists demand it, or the studios feel they can create a demand among the artists. And don't forget there's a small but hard core of audiophile recording engineers who cheerfully buy into Microsonics' sonically-flawed-CD story. These are the same guys who wire their studios with multi-dollar-a-foot esoteric cables. Will the HDCD processors ever be as ubiquitous in recording studios as Dolby encoders? I doubt it.

Am I an aging cynic who wouldn't know a genuine audio advance if it hit him between his no-longer golden ears—or have I, by a combination of technical good sense and market savvy, correctly predicted the course of a newly promoted product? Time, perhaps a year or so, will tell. **EN**



# This month we start the design of a general-purpose controller circuit.

**W**Henever I have to start on a new project here, the first place I search for ideas is in the mail. Historically speaking, my mail has changed over the years.

Once upon a time, the majority of the requests I received were for coverage of very general subjects—a tutorial on op-amps, for example, or how to design with FETs. In the last few years, though, the requests have changed.

Most of the mail now concerns specific applications rather than general ones. This is okay with me because I've always believed that you learn more by working with real-world circuits. The only problem with doing this is that the projects often get so complex that the general theory behind them tends to get lost. Without a thorough understanding of the underlying theory, all you're really doing is building a kit. This becomes evident if you try to change to the design because you suddenly realize that while you might have built a circuit, you don't understand how it works—or why it doesn't work!

The best way for me to answer all the application-specific requests I've received is to design a circuit that can do many things with minimum changes to the design. The best way to design such a chameleon-like circuit is to base it on a microprocessor. Once you have a basic microprocessor circuit working with a good amount of

controllable input/output (I/O), you can alter its function just by writing new software.

Designing a general-purpose controller circuit isn't all that difficult, but it is definitely more complicated than using discreet logic. The price you pay for a microprocessor's versatility is that you must know how the microprocessor works and how it can be programmed.

Different microprocessors require different support hardware and software. However, they differ only in the details—the principles are the same. If you can design around Intel microprocessors, you won't have any trouble adjusting to the Motorola family. I'll be using an Intel microprocessor here because they're inexpensive and easy to find. Perhaps the most important reason to use Intel processors is that you'll need to write software, and every version of DOS comes with utilities that make the job of converting source code to Intel-compatible binary files easy to do. Finally, I've designed many circuits around Intel processors, seen most of the problems, and have worked out most of the answers.

Over the next several columns,

1	V <sub>SS</sub>	V <sub>CC</sub>	40
2	A14	A15	39
3	A13	A16/S3	38
4	A12	A17/S4	37
5	A11	A18/S5	36
6	A10	A19/S6	35
7	A9	S50	34
8	A8	MN/MX	33
9	AD7	RD	32
10	AD6	8088 HLD	31
11	AD5	HLDA	30
12	AD4	WR	29
13	AD3	IO/MEM	28
14	AD2	DT/RCV	27
15	AD1	DEN	26
16	AD0	ALE	25
17	NMI	INTA	24
18	INTR	TEST	23
19	CLK	RDY	22
20	V <sub>SS</sub>	RST	21

**FIG. 1**—THE 8088 MICROPROCESSOR is really a 16-bit chip squeezed into an 8-bit package.

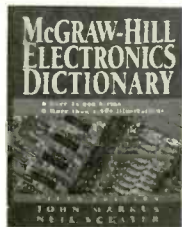
I'm going to design a general-purpose, microprocessor-based controller circuit, with software configurable I/O. Although I'll go through each step in detail, it will be impossible for you to follow unless you have the following:

1. Data sheets on the ICs we'll be using
2. A basic understanding of microprocessors
3. A general understanding of programming
4. Access to an oscilloscope
5. A familiarity with hex code
6. Access to an EPROM programmer

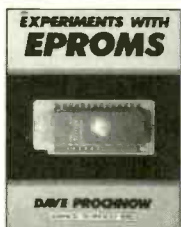
# Get 3 books for only \$9.95 Plus 1 book FREE upon prepayment

when you join the **Electronics Engineers' Book Club®**

Values to \$197.45



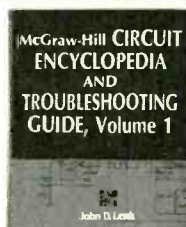
**0404348 \$49.50**  
More than 14,000 entries and 1,500 illustrations make up this A-to-Z reference. Its up-to-date definitions cannot be found in general dictionaries. Plus, it focuses on terminology specific to the field of electronics.  
608 pp., 1,500 illus.



**2962P \$18.95**  
This complete EPROM instruction manual provides a detailed explanation of underlying theory, plus 15 different projects—including programmers, erasers, and EPROM-based circuits. 240 pp. Softcover.



**0289778-XX \$49.00**  
Unleash the power of controllers with this guide. You'll see how a controller can be used in anti-lock brakes, cash registers, and robotic systems. You get details on controllers such as the Motorola 8-bit MC68HC11, and the 32-bit Intel 8051 and 80960CA to help you use devices in your projects. 350 pp., 125 illus. *Counts as 2*



**0376034-XX \$59.50**  
This book provides both a collection of over 700 of the latest commonly used integrated and discrete-component circuits and authoritative testing and troubleshooting methods on each type of circuit. You can use the circuits "as is" or modify the circuits to your specifications. 664 pp., 703 illus. *Counts as 2*



**3837H \$27.95**  
This guide focuses on the specific digital circuits used in electronic power applications. It presents state-of-the-art approaches to analysis, troubleshooting, and implementation of new solid-state devices. 272 pp., 197 illus.



**0491836 \$29.95**  
Plan and implement telecommunications projects. Assess market trends for voice and data services. Procure a voice/data premises distribution system. You can accomplish these tasks and many more with the advice in this guide. 384 pp., 159 illus. Softcover.



**0039615 \$40.00**  
How many times have you looked at the manufacturer's specs for a particular component and *assumed* it was correct? Here is your guide to basic electrical and component measurements, system tests, and performance verification. 224 pp., 180 illus.



**032381X-XXX \$119.50**  
This bestseller provides detailed information on physical fundamentals, patterns, structures, and design techniques. Experts from RCA, Raytheon, Scientific-Atlantic, and other major firms and universities have contributed to this book. 1,520 pp., 800 illus. *Counts as 3*



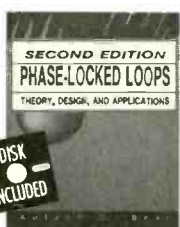
**031716X-XX \$50.00**  
Cover the basics of all the important video technologies in this one comprehensive volume. You'll find information on the production, recording, editing, transmission, distribution, and display of video signals including: picture quality, especially as it relates to HDTV ... digital video ... fiber optic transmission systems ... and more. 300 pp., 120 illus. *Counts as 2*



**037516X \$39.50**  
This helpful volume covers digital electronic devices and components and a simplified system of testing and troubleshooting that can be easily applied to any electronic system or equipment. 320 pp., 150 illus.



**4228P \$19.95**  
Get all the hands-on instruction you need to translate RF theory into functioning hardware and design working RF power circuits with this guide. 304 pp., 219 illus., Softcover.



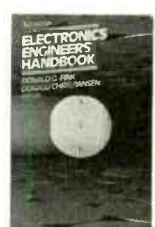
**9113869-XX \$50.00**  
Design efficient phase-locked loops for electronic devices. You get design and applications information for all four types of PLLs—linear, digital (an analog/digital hybrid), all-digital, and software. 370 pp., 100 illus., 5.25" disk, *Counts as 2*



**0059276 \$29.95**  
Assemble a custom-made workstation with the tips in this book. Step-by-step instructions make it simple for anyone to install RAM chips, hard and floppy drives, graphics cards, motherboards, CD-ROM drives, and more. 336 pp., 60 illus., Softcover.



**0709645-XX \$70.00**  
Explore the technological trends and details of telecommunications transmission equipment with this guide. Fully illustrated, coverage includes packet switching; the advantages, disadvantages, and details of direct RF modulation; and more. 560 pp., 440 illus. *Counts as 2*



**9255H-XXX \$105.50**  
"Outstanding, extensive reference to current technology of electronics. Covers everything from principles to applications."  
—Computer Book Review  
2,528 pp., 1,800 illus. *Counts as 3*



**02628432 \$60.00**  
Keep up with the changes in top-level microprocessors with this newly revised edition. It covers the latest high-potential systems, such as Pentium, PowerPC, DEC Alpha, SuperSPARC, and others. 580 pp., 155 illus.



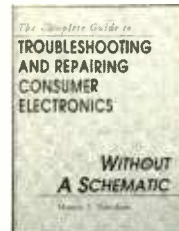
**0679304 \$40.00**  
Whether you're an optics professional or an engineer or technician interested in the field, you'll appreciate this easy-to-read introduction to modern optical engineering—ranging from the basics of lens selection and system evaluation to the latest design and analysis methods. 362 pp., Illustrated.



**0042144 \$39.00**  
This book provides a solid introduction to programmable controllers. You'll explore how to use personal computers with programmable controllers as well as how to compare and select process control schemes. 304 pp., 180 illus.



**0297894 \$45.00**  
Make the most of your LT package to get production-quality results and create top-flight presentations. This book shows you how to take advantage of special tricks, tips, and techniques like drawing borders in paper space, transferring images between applications, and more. 345 pp., Illustrated.



**0156492 \$34.95**  
Tackle troublesome circuits without the benefit of a schematic with these tricks of the trade by a veteran electronics technician. You'll see how to locate, test, and repair defective components in virtually every type of consumer electronics device imaginable. 304 pp., 250 illus.



**0209847-XXX \$110.50**  
Benefit from the collective expertise of more than 100 contributors in this book. It's the most current and comprehensive electrical reference available today. 2,208 pp., 1,421 illus. Counts as 3



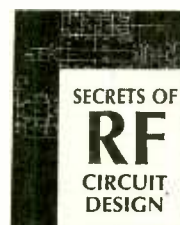
**0376026 \$42.95**  
Make testing hassle-free with the help of best-selling author John D. Lenk. He details the types of test equipment available, what the various types do, and how they operate. Plus, he offers procedures for testing electronic devices, circuits, and components. 416 pp., 526 illus.



**0443017 \$40.00**  
Covering both analog and digital cellular systems, this book provides complete coverage of the principles and design techniques for cellular systems. 224 pp., 142 illus.



**4473P \$29.95**  
This thought-provoking book covers the basic components of an artificial neural network; multilayer feedforward networks; Hopfield networks; Boltzman machines; unsupervised learning; and a host of other cutting-edge topics. 208 pp., 35 illus., 3.5" disk. Softcover.



**3710P \$21.95**  
Understand the basics of receiver operation, the proper use and repair components in RF circuits, and principles of radio signal propagation from low frequencies—all with this guide. 416 pp., 411 illus., Softcover.

## As a member of the Electronics Engineers' Book Club...

... you'll enjoy receiving Club bulletins every 3-4 weeks that contain exciting offers on the latest books in the field—at savings up to 50% off regular publishers' prices. If you want the Main Selection, do nothing and it will be shipped automatically. If you want another book, or no book at all, simply return the reply form to us by the date specified. You'll have at least 10 days to decide. If you ever receive a book you don't want due to late delivery of the News, you can return it at our expense. Plus, you'll be eligible for **FREE books** through the Bonus Book Program. Your only obligation is to purchase 3 more books during the next 2 years, after which you may cancel your membership at any time.

All books are hardcover unless otherwise noted. Publishers' prices shown. If you select a book that counts as 2 choices, write the book number in one box and XX in the next. If you select a Counts as 3 choice, write the book number in one box and XXX in the next 2 boxes. ©1995 EEBC

A shipping/handling charge & sales tax will be added to all orders.

If card is missing, write in:

Electronics Engineers' Book Club, A Division of McGraw-Hill, Inc.  
P.O. Box 549, Blacklick, OH 43004-9918

Phone: 1-614-759-3666

(8:30 a.m. to 5:00 p.m. EST Monday-Friday)

FAX: 1-614-759-3749 (24 hours a day, 7 days a week)

## ELECTRONICS ENGINEERS'® BOOK CLUB

A Division of McGraw-Hill, Inc., P.O. Box 549, Blacklick, OH 43004-9918

**YES!** Rush me the following title(s), billing me just \$9.95 (plus shipping/handling & sales tax). Enroll me as a member of the Electronics Engineers' Book Club according to the terms outlined in this ad. If not satisfied, I may return the book(s) within 10 days for a full refund and my membership will be cancelled. I agree to purchase just 3 more selections at regular Club prices during the next 2 years and may resign anytime thereafter.

Bill me (FREE book not available with this payment option.)

**SPECIAL OFFER!** Prepay your order by check, money order, or credit card and receive a 4th book of your choice FREE.

**YES!** I want the FREE BOOK indicated at right. My introductory payment of \$9.95 plus \$9.95 shipping/handling\* and applicable sales tax is enclosed.

Code # of my FREE BOOK:

SINGLE SELECTION ONLY

Code #'s of my book(s) for \$9.95

--	--	--	--

If you select a book that counts as 2 choices, write the book number in one box and XX in the next. If you select a Counts as 3 choice, write the book number in one box and XXX in the next 2 boxes.

Check or money order enclosed made payable to: McGraw-Hill, Inc. Please charge my:  VISA  MasterCard  American Express  Discover

Acct. No. \_\_\_\_\_ Exp. Date \_\_\_\_\_

Name \_\_\_\_\_ Signature \_\_\_\_\_  
(required on all credit card orders)

Address / Apt.# \_\_\_\_\_

City/State/Zip \_\_\_\_\_ Phone \_\_\_\_\_

Offer valid for new members only, subject to acceptance by EEBC. U.S. orders are shipped 4th Class Book Post. Canada must remit in U.S. funds drawn on U.S. banks. Canadian orders are shipped International Book Post—add \$12.50 shipping/handling. Applicants outside the U.S. and Canada will receive special ordering instructions. A shipping/handling charge & sales tax will be added to all orders. DRE1095



**FIG. 2—THE 8284 CLOCK CONTROLLER** will produce clock signals that are exactly tailored to driving the 8088.

It's sometimes hard to find books on this subject and that's why I wrote one myself. It's called "The 8088 Project Book," Book #3171 from TAB Books (800) 822-8158. You won't find data sheets (or an oscilloscope) in the book, but it will probably answer any questions you have concerning microprocessors.

### The 8088 CPU

The 8088 microprocessor, whose pinout is shown in Fig. 1, is a field-tested CPU that you can buy for about a buck. If you look at the pin names, you'll notice that some of the pins perform double duty. This is because the 8088 is really a 16-bit chip squeezed into an 8-bit package. The standard 40-pin DIP just doesn't have enough pins for every line to be

brought out separately.

A microprocessor needs a clock signal, memory, and software to tell it what to do. The 8088's pin-multiplexing scheme requires some additional, minimal hardware.

### CPU satisfaction

The first of the 8088's circuit requirements is a clock signal, and this is pretty easy to satisfy. The clock must have sharp shoulders (rise and fall times of less than 10 microseconds) and a 33% duty cycle. The maximum speed depends on the CPU. A standard 8088 tops out at 4.77 MHz, the 8088-2 can run at 8 MHz, and the 8088-1 goes up to 10 MHz. Minimum speeds for all flavors of the CPU is about 2 MHz because the internal registers are made from single storage capacitors that must be refreshed in the same way as dynamic RAM. This saves space on the substrate, but it made it a bit more difficult to really slow things down to debug a circuit. Since you can't slow the clock to a crawl, you must use software to put in lots and lots of wait states to get the same effect.

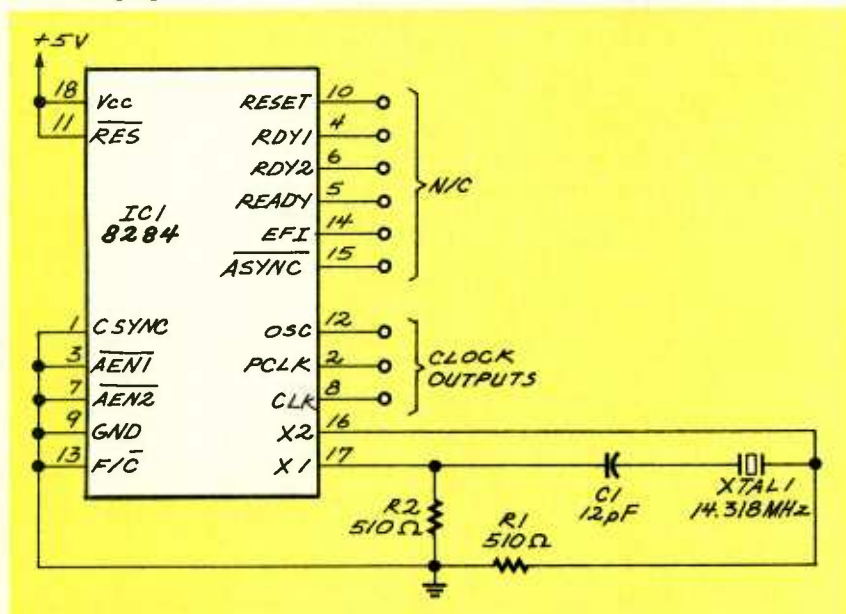
When Intel first started to design the 80XX series of microprocessors, one goal was to offer a set of chips specifically designed to support the CPUs. These included clock generators, bus controllers, coprocessors, DMA controllers, and so on. Some of

them became popular and others didn't. One of the most popular was the 8284 clock controller shown in Fig. 2. This chip, plus a handful of components, will produce clock signals that are exactly tailored to driving the 8088.

Getting the 8284 to generate the clock signals for the CPU is a piece of cake. As you can see in the circuit of Fig. 3, most of the control and data pins on the 8284 aren't needed for the simple job that we want the chip to do. They come into play when the clock generator must drive more than one CPU or generate more than one clock frequency. My circuit will use the 8284 in its simplest configuration—as a clock source for the 8088.

You have to get the clock circuit working before you can go any further since it's going to drive the rest of the circuitry you'll be assembling over the next few months. It's simple to find out whether or not you have the clock circuit working correctly. There are three clock outputs available on the chip: +sclck+xsc at pin 8 is the main output for the 8088. It's one third the crystal output and has a duty cycle of 33% that's required by the 8088. OSC at pin 12 is a TTL-level buffered version of the crystal frequency. PCLK at pin 2 is a TTL-level frequency that's equal to half the CLK output and has a 50% duty cycle.

If you put an oscilloscope or frequency counter on any of those outputs, you'll know immediately if the clock is working correctly. Next time I'll be adding the CPU, creating the address and data buses, adding memory, and putting some basic I/O on the board. A lot of information is going to be thrown at you and you'll stand a lot better chance of catching it if you have the basic data on paper in front of you. **EN**



**FIG. 3—WE'RE USING THE 8284** in its simplest configuration as a clock source for the 8088. Most of the control and data pins on the 8284 aren't needed for this project.



# Windows 95 update

*Has Windows 95 achieved its intended design goals?*

**W**INDOWS 95 SHOULD BE COMMERCIALY AVAILABLE BY THE TIME YOU READ THIS, SO AT LONG LAST YOU'LL GET A CHANCE TO CHECK IT OUT FOR YOURSELF. FOR MORE THAN A

year now, I've been playing with various pre-release versions of it, studying its architecture, comparing and contrasting it with its predecessors as well as other OS's. Barring any unforeseen last-minute catastrophes, what you will see should be very, very close to what I'm using now. This column describes what you can expect. It also provides my evaluation of how well Microsoft achieved its explicit design goals for Windows 95.

## Installation hassles

Installation on older hardware can be difficult, but once you get the kinks straightened out, using Windows 95 can really grow on you. I now have Windows 95 running on two nodes of my network. One node, an old IBM PS/2 Model 70 (with 8 megabytes of memory and a 25 MHz 80386 CPU), functions as a print server, and will (by the time you read this) function as a remote-access server, allowing me to dial in by modem and access my network as if I were local. (Note: This is a good use for an old 386.) The remote-access feature is part of the current Windows 95 beta, but may be sold as a separate product by the time

Windows 95 is released commercially. Note that Windows 95 (not to mention Windows for WorkGroups and Windows 3.11) will not run on a computer with anything less than an 80386 micro-processor.

The other Windows 95 node is a custom-built 486-based PC with 8 megabytes of memory. At the beginning of this experiment, that machine had an Always Technology SCSI adapter, and an old Paradise VGA card. The bad

news was that I had to upgrade the disk controller, and chose to upgrade the video card. The SCSI problem was that the Always adapter card simply couldn't run both a hard disk and a CD-ROM. Lock-ups were frequent—and fatal.

I wanted to buy an Adaptec brand adapter, but the cost exceeded my budget for that old machine. Instead I gambled on a low-cost card made by a company called QLogic. I had no trouble installing it and running both hard disk and CD-ROM. Currently the setup uses "real-mode" drivers loaded via CONFIG.SYS and AUTOEXEC.BAT. QLogic had a beta protected-mode driver for the card available on its BBS, but it didn't work for me. I'm hopeful

TABLE 1—WINDOWS 95 EVALUATION

Criteria	Grade	Description
Ease of use	A	Definite improvement over Windows 3.x
Performance	B	No worse than WFWG; adequate on 386-25/8MB
Compatibility	B	Adequate; ran all software I threw at it; some hardware problems.
Networking and connectivity	B	Easier HW setup than WFWG, but configuration still lacking.
Manageability and administration	A	Definite improvement over Windows 3.x. Easy switching among user and hardware profiles.
Communications and messaging	?	Retail configuration still TBD.
Mobile services and remote access	?	Not evaluated.

that the company will produce a usable protected-mode driver soon, but at least the real-mode drivers are stable.

The reason I want the protected-mode drivers for the QLogic adapter is that they will run in the 32-bit mode of the CPU, rather than the V86 mode, where the real-mode drivers run. The 32-bit mode will eliminate the need for mode switching, and will allow use of more-efficient 32-bit code.

The video situation was somewhat different. One application that had to run on that machine required a 256-color video driver, but the 1989-era Paradise card could only do so at standard VGA resolution (640 × 480), which was intolerable for me. So I bought another low-cost clone card: this time a Trident, with 1 megabyte of memory. The machine booted right up in standard VGA mode, but after allowing Windows 95 to auto-detect the new card and install a new driver, the machine repeatedly froze at a specific point in the boot sequence. I tried reinstalling Windows several times, always with the same result.

Then I received a Windows 95 update (build 490) from Microsoft, and it solved the problem. One useful tool in resolving the problem was Windows 95's ability to boot in a "safe" mode, in which only bare-minimum device drivers are loaded. I used safe boot many times in resolving problems with that machine and others.

The total cost for getting the old up to Windows 95 speed was about \$250, plus another \$300 to replace an eight-year old NEC monitor, which opportunely chose that time to die. In terms of effort, I had to reinstall Windows 95 several times, and reconfigure numerous system parameters. Based on this experience, I believe that there is no way that nontechnical users with older machines can count on getting a smooth Windows 95 upgrade. Even technical users had better be prepared for some frustration, and possibly some expense.

On the other hand, once you surmount the installation hurdles, Windows 95 is actually kind of nice.

There is a consistency to the user interface that has been sorely lacking in prior versions of Windows. Although it is only a surface consistency (unlike OS/2), I still predict that it will become widely successful. By the time Memphis is released—the point where the Windows 95 and NT product lines converge in a distributed, object-oriented operating system—that consistency should extend well beneath the surface (as in OS/2).

One thing I don't like about Windows 95 is that it's slower to boot than prior versions of Windows. On the other hand, if you press F8 while the message "Starting Windows 95" is displayed, you get a menu that allows half a dozen or more ways to boot (command-line, GUI, safe-mode command line, safe-mode GUI, safe-mode GUI with networking, and more).

### Windows 95 networking

Although I probably could, I still don't use Windows 95 on my main production machine, which continues to run Windows for WorkGroups 3.11. The Windows for WorkGroups machine does, however, provide clean access to the Windows 95 print server; likewise, I can also share the Windows for WorkGroups machine's resources with the Windows 95 nodes. Using Microsoft's little-known WorkGroup Add-On for MS-DOS, I can also access network resources from DOS-only machines.

Getting the network up and running was a piece of cake. Windows 95 correctly auto-sensed a variety of Ethernet cards installed in the various machines, and installed the correct drivers. Windows 95 automatically installs the IPX protocol stack for communicating with a NetWare network, but if you're only running Windows 95 and Windows for WorkGroups, IPX is unnecessary; Microsoft's NetBEUI is all that is required. Deleting the IPX drivers was simple enough, but installing them by default seems silly. By contrast, sharing the resources of a machine with others on the network is disabled by default—which also seems silly to me.

All in all, getting Windows 95 net-

working going was easy enough for me, but people without network-installation experience would in all likelihood require technical support to complete the installation. Microsoft could have done more to ease installation, but perhaps the company chose explicitly not to. Microsoft's current plan is to provide 90 days of free technical support (by telephone) for non-network related questions, and to charge \$35 per network "incident."

### Evaluation

My evaluation appears in Table 1; criteria in the table are those suggested by Microsoft on page five of the *Microsoft Windows 95 Reviewer's Guide*. In sum, Windows 95 has not met Microsoft's architectural goals; nonetheless, it is a major step forward in PC operating systems. If it turns out to be a short-lived step on the way to a more robust architecture based on Windows NT, so much the better. But the user-interface improvements provided by Windows 95 will be with us for a long time.

### IBM buys Lotus

I don't want to say I told you so, but just remember you read it here first—in the July 1994 issue to be exact.

If you had \$3.5 billion in spare change lying around, and wanted to do something to help ensure the longevity of your company, how would you spend it? Would you invest in exciting new technology R&D? How about some heavy-duty industrial espionage?

Let's put it another way. Suppose you were a broken-down old has-been playing an exciting but deadly game of craps with a powerful young chieftain. What's the best way of increasing power at the expense of your rival? Join forces with a complementary operation—albeit one suffering from an indifferent outlook and premature aging?

Some early commentators think that (if the deal goes through) IBM will focus on Lotus Notes, making it the centerpiece of a communications and integration infrastructure for

*Continued on page 89*

## SCHEMATIC CAPTURE

continued from page 36

**Product:** WinScheme  
**Version:** 1.2  
**Price:** \$179  
**Platform:** Windows  
**Publisher:** The Great SoftWestern Co., Inc.

WinScheme is a Windows schematic capture program that's very easy to learn and use. The program was originally written as an update for Schema to change the raster display to a vector display for more detailed images with faster response. However, Omation sold Schema to Accel Technologies (the makers of Tango, a high-end schematic capture/PC board layout package) before the project was finished. The result is a modified version of the original program with a different look and feel—and a low \$179 price.

Just because the project was cut short, the software certainly wasn't. WinScheme is every bit as powerful as schematic capture programs costing much more. For example, it has a long list of file output formats for linking WinScheme schematics with many popular PC board layout programs, including OrCAD and Tango. It provides forward-annotation capability, where changes in the schematic are automatically reflected in the PC board layout for those formats that support it. And if those features aren't enough, you can also import WinScheme drawings into PSpice or Susie for analog and digital simulation, respectively.

Like SuperCAD+ for Windows, WinScheme supports MDI which lets you group and simultaneously load multiple schematics under a project umbrella for easy management. However, the drawings are not related, so they don't interrelate when it comes to preparing bill of material lists or doing design rule checking. SuperCAD+ for Windows schematics can be linked.

Frequently used schematic

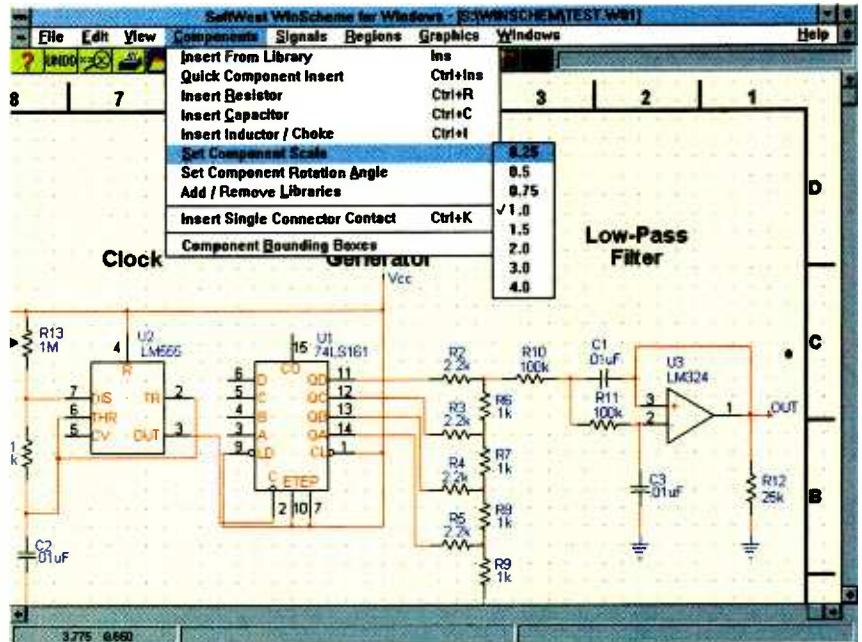


FIG. 11—WINScheme IS A WINDOWS SCHEMATIC CAPTURE PROGRAM with an abundance of built-in netlist formats, including PSpice and Susie simulation formats.

symbols, such as resistors and capacitors, can be quickly placed on the drawing from a pull-down menu or by using keyboard shortcuts (see Fig. 11). However, the majority of symbols are placed by highlighting the part from one of the component libraries. The library menu has a symbol previewer that shows you what the component looks like as you browse through the libraries. Unfortunately, repeat placement isn't supported. WinScheme comes with nearly 1000 predefined symbols, and creating new devices is simple enough.

Unlike most schematic programs, you must enter the edit command before selecting the part to be edited. Clicking on a part without selecting an edit command brings up an information menu that lets you edit the component reference designator and value parameters. Attached nomenclature—including pin numbers—can be moved, copied, and rotated. The zoom is among the best in the business, with a 10,000-to-1 zoom ratio. You can set the zoom scale manually with a dialog box, or by drawing a box around the area you want to be magnified.

Wires are drawn with an auto router. All you do is click on the end points, and the router

draws the wire for you, avoiding components and adding junctions as needed. For large designs, you can connect two components by entering the device references and pin numbers into a dialog box. All wires must have valid beginning and ending points; floating wires and dangling ends aren't permitted. This is done to preserve the integrity of the netlist, which otherwise would flag such occurrences as errors. While WinScheme supports rubberbanding, it works only with block moves. Wires will not stretch to follow a moved discrete device unless it's inside a block. A nifty feature, called a wire optimizer, minimizes wire lengths after making block moves.

WinScheme is a good schematic capture program with a lot of nice features. The number of netlist formats is second to none, the editing tools are powerful and easy to use, and the library is big enough to handle all but the most challenging designs. The only real complaint is the lack of linking between schematics, a drawback that essentially limits your design to whatever you can squeeze onto a single page. But this is an early release version, and the author promises a substantial upgrade in version 2.0,

which should be available later this year. If you like the program, don't wait for the upgrade. The new release will be backward-compatible, and will be offered at a substantial discount to version 1.2 owners.

<b>Product:</b>	CircuitMaker
<b>Version:</b>	2.6
<b>Price</b>	\$299
<b>Platform:</b>	Windows
<b>Publisher:</b>	MicroCode Engineering

CircuitMaker is an integrated Windows schematic capture and circuit simulation program with a \$299 price tag. Like Interactive Image's Electronics Workshop, CircuitMaker is targeted at the user who wants to turn the PC into an electronic breadboard, complete with software-emulated power supplies, signal generators, voltage/current meters, and an oscilloscope. Here, we'll concentrate on the schematic drawing portion of the package. Besides CircuitMaker's ease of use, it also has excellent editing features. More precisely, its edit-after-placement features are outstanding—but this turns out to be a double-edged sword, because you must use them frequently.

For example, you can't define a part's value during placement; it must be done afterwards. No, it's not like some of the schematic draw programs reviewed here where the values are unattached pieces of text. All device references are a part of the component, and they move as the part moves. It's just that in the beginning they're all the same. For example, the default value for fixed resistors is 1 kilohm, while capacitors—both fixed and variable—are given a value of 1  $\mu$ F; inductors default to 1  $\mu$ H. That means you will be forced to use the editor to change the values to those that your design requires—and that's why you'll be glad the editor is so easy to use.

Double clicking on any part of the circuit brings up a menu that lets you change any of the circuit's attributes, including its part value. Moreover, should

any of the part's nomenclature conflict with another device or text, it can be moved and rotated by a simple drag and drop operation. The parts, too, are easily moved and oriented with simple mouse clicks and/or keystrokes. An excellent menu bar lets you place wires, junctions, and components without having to access a menu. And there's rubberbanding for both devices and blocks. However, the rubber wires snap to orthogonal routing, which can be annoying when moving a multipin device because the wires often overlap into what looks like a bus on the drawing, without labels.

The component library comes with all the devices needed to draw the rather-demanding example schematic, plus a surprising number of objects you wouldn't expect to find in a library this small, like a programmable 1 kilohm RAM chip with SPICE parameters. But finding the parts can be a test of patience. That's because the 217 library symbols are simply tossed into 10 pull-down menus, with no rhyme or reason to their order—and there's no dialog box shortcut. That means you often have to search through several menus before finding the part you are seeking for (see Fig. 12). What's worse, as

new devices are added, they are tacked on to the end of this queue in the order in which they are created. When a pull-down menu is full (each menu holds just 24 parts), CircuitMaker automatically creates a new pull-down menu and proceeds to fill it. This is clearly a clumsy way to catalog components. Thankfully, once a part is accessed from the library, it can be repeatedly placed on the drawing. Auto annotation and on-the-fly rotation/mirroring is provided, as is global re-annotation after placement. A nice touch is CircuitMaker's ability to turn off repeat placement and auto annotation individually, which speeds up the drawing of simple schematics.

There are two ways to create new devices. If you need a complex design, such as a phase-locked loop, the fastest method is to use CircuitMaker's macro editor, which assembles the device from other library components. For simpler devices, such as a neon lamp, the best method is to create the device from primitives (lines and circles) with a drawing program, like Paintbrush. The knack to using a drawing program, though, is adjusting the new part's size to match those already in the library, which takes practice.

It is very easy to draw a profes-

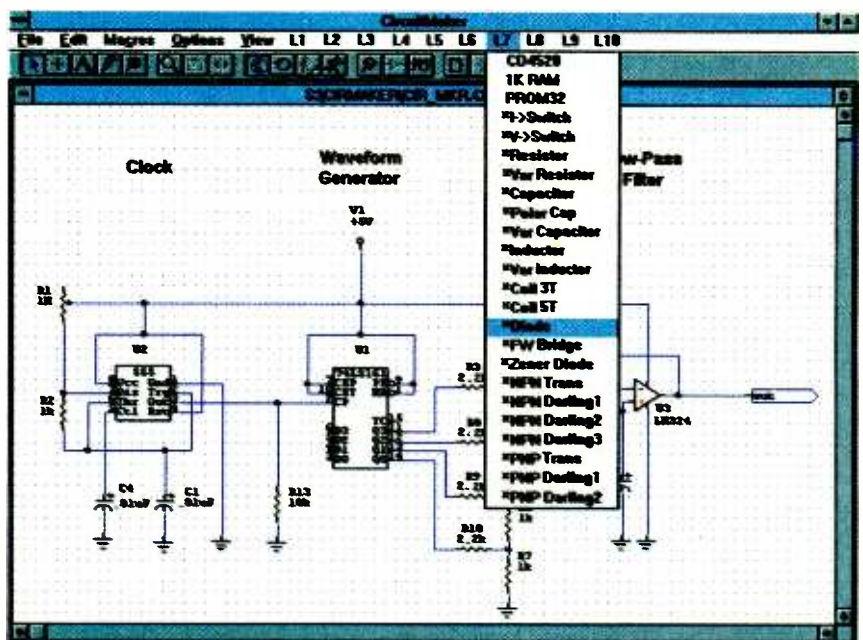


FIG. 12—CIRCUITMAKER IS AN INTEGRATED SCHEMATIC CAPTURE and circuit simulation program with excellent editing features.



sional-quality schematic with CircuitMaker, and its powerful analog/digital circuit simulator is even better. For the circuit designer who doesn't need PC board layout, this is an excellent choice. You can find a demonstration version of it on the Gernsback BBS. The demo's also available, along with online technical support and upgrades, on CompuServe.

<b>Product:</b>	Electronics Workbench
<b>Version:</b>	4.0
<b>Price</b>	\$299
<b>Platform:</b>	DOS or Windows
<b>Publisher:</b>	Interactive Image Technologies

Touted as "The electronics lab in a computer," Electronics Workbench is an integrated schematic capture and circuit simulation program whose primary purpose is the design and verification of circuits using your PC as a test bed. While that's true, it does a decent job of drawing schematics, too, and can generate OrCAD netlists for PC board layout (the latter is a \$75 extra cost option). Electronics Workbench sells for \$299, the same as CircuitMaker, its closest competitor.

Electronic Workbench comes in both a DOS and Windows version which are practically identical. The screen is conveniently laid out, with the library parts located in a column on the left, and the libraries expressed as icons in the toolbar just above the worksheet (see Fig. 13). Parts are placed on the drawing by clicking on the library symbol, dragging it to its destination, and dropping it into place. Part rotation is done after placement. While there's no mirror function per se, the rotation command eventually gives you mirrored versions of many of the devices if initiated often enough. (For example, after three rotations, the inverting and noninverting inputs of an op-amp trade places; another rotation flips the op-amp left to right for true mirroring.) Unfortunately, most logic devices, which constitute up nearly three-fourths of the library's

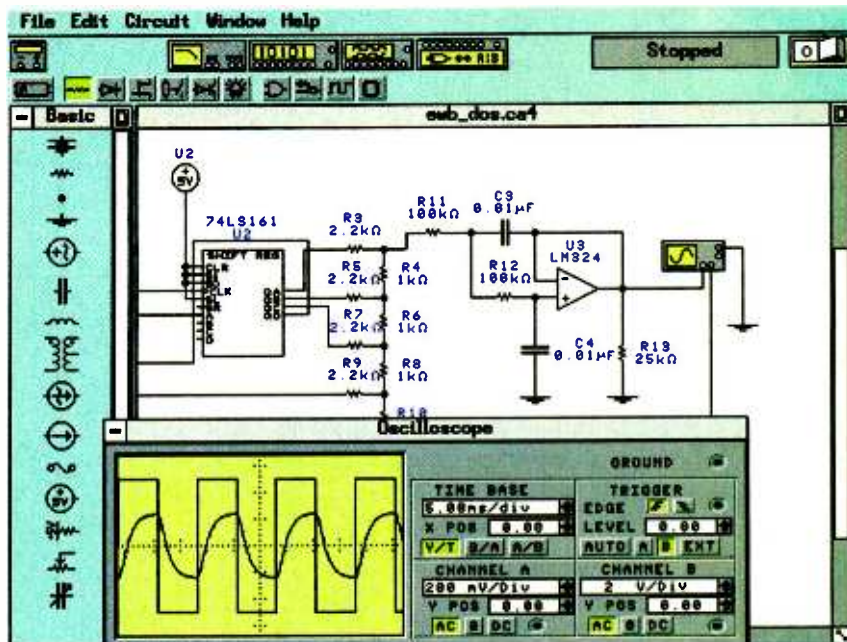


FIG. 13—PLACING PARTS on an Electronics Workbench schematic is as easy as clicking on the symbol icon and dragging it into place.

350 devices, can't be rotated. You can let the auto router place wires on the diagram by clicking on the destination and dragging the wire to a valid termination; the auto router maps the route, avoiding components and other wires.

Components can be moved with a simple click and drag procedure; rubberbanding is always engaged, so components never lose connection. However, the results are often less than pleasing, with wires that crisscross so often that they're hard to trace. A complex series of moves took nearly 20 minutes to sort the jumble of wires—a process that was complicated by Electronics Workbench's lack of block moves and zoom.

Double clicking on a part brings up a menu that lets you modify various parameters, depending on the kind of part it is. For example, double clicking a resistor lets you set its value (default is 1 ohm). Double clicking on an 74xx brings up a menu of logic devices, from which you can choose CMOS or TTL logic, and the device type (e.g., 74LS08). It has a library of "ideal" gates that can be converted to real-world devices as the design matures. To change other parameters, such as part reference, you have to highlight the part and choose the appropriate

edit command from the circuit pull-down menu. All nomenclature is fixed in place, and can't be moved or edited.

Unlike CircuitMaker, Electronics Workbench won't let you create new devices; only Interactive can do that. However, designs can be saved as subcircuits in a library, which appear as boxes on a new schematic. That means you can create compound components, like an LM555, from gates and transistors. Selecting the semiconductor that equal the performance of the real part, however, is a challenge. Additional library modules are available for \$75 each (\$200 if you buy all four).

The DOS version has an adjustable percentage formula that lets you fit the drawing to the page—if you take the time to figure out what percentage it takes to fill the page. Plotters are supported only in the Windows version, which basically supports any output device you have loaded into your Windows print manager. The DOS version also has a screen capture feature that saves the schematic to a PCX file (which was used for Fig. 13).

### Schematic capture with PC board layout

The programs described pre-

TABLE 1

	AutoSchem	BoardMaker I	CADPAK II ISIS Supersketch	CircuitMaker	Easy-PC	Easy-PC Pro	Electronics Workbench	EZ-Route Sid EZ-Logic	Schematic Plus	SuperCAD	SuperCAD for Windows	TurboCAD for Windows	WinScheme
Price	\$29	\$95	\$159	\$299	\$195	\$349	\$299	\$249	\$20	\$99	\$149	\$99	\$179
Format	DOS	DOS	DOS	Windows	DOS	DOS	Win/DOS	Windows	Windows	DOS	Windows	Windows	Windows
RAM required	384K	512K	640K	2MB	512K	640K	4MB	512K	2MB	640K	1MB	2MB	2MB
Hard disk required	N	N	2MB	7MB	N	5MB	4MB	3MB	N	N	2MB	N	10MB
<b>Schematic</b>	Y	Y	Y	Y	Y	Y	Y	Y	Y	Y	Y	Y	Y
Capture	N	N	N	Y	N	Y	Y	Y	N	Y	Y	N	Y
PCB netlist	N	N	N	N	N	Y	Y(1)	Y	N	Y	Y	N	Y
Simulation netlist	N	N	N	Y	N	Y	Y(1)	Y	N	Y	Y	N	N
Design rule check	N	N	N	N	N	Y	Y	Y	N	Y	Y	N	Y
<b>PCB Layout</b>	N	Y	Y	N	Y	Y	N	Y	N	N	N	N	N
<b>Circuit Simulation</b>	N	N	N	Y	N	Y(1)	Y	N	N	Y(1)	Y(1)	N	N
Analog	N	N	N	Y	N	Y(1)	Y	N	N	Y(1)	Y(1)	N	N
Digital	N	N	N	Y	N	Y(1)	Y	N	N	Y(1)	Y(1)	N	N
<b>Drawing Features</b>													
Ortho disable	n/a	Y	Y	N	Y	Y	N	Y	N	Y	Y	Y	N
Diagonal wires	Y	Y	Y	N	Y	Y	N	Y	N	Y	Y	Y	N
Auto annotate	N	N	Y	Y	N	Y	N	Y	Y	Y	Y	N	Y
Supports buses	N	N	Y	Y	N	N	N	Y	N	Y	Y	N	Y
Repeat object placement	N	Y	Y	Y	Y	Y	N	Y	N	Y	Y	Y	N
Rotate part prior to place	Y	Y	Y	Y	Y	Y	N	N	Y	M	M	Y	Y
Zoom range/on-the-fly	n/a	Y	Y	20:01	Y	Y	N	Y	n/a	draw to fit	24:1	n/a	10,000:1
Auto pan	N	Y	Y	N	Y	Y	Y	Y	N	N	N	Y	N
Find/search	N	N	Y	N	N	N	N	N	N	Y	Y	N	N
<b>Editing Features—Placement</b>													
Rotate	N	Y	Y	Y	Y	Y	Y	Y	Y	Y	Y	Y	Y
Mirror	N	Y	Y	Y	Y	Y	N	Y	N	Y	Y	Y	Y
Find	N	N	Y	N	N	N	N	N	N	Y	Y	N	N
Undo	N	N	Y	Y(2)	N	N	N	Y	N	Y	Y	N	N
Rubberband	N	Y	Y	Y	Y	Y	Y	Y	N	Y	Y	N	Y
<b>Block</b>													
Move	Y	Y	Y	Y	Y	Y	Y	Y	N	Y	Y	Y	Y
Hide	N	N	N	N	N	N	N	N	N	N	N	Y	N
Delete	Y	Y	Y	Y	Y	Y	Y	Y	Y	Y	Y	Y	Y
Save	Y	Y	Y	Y	Y	Y	Y	Y	N	N	N	Y	Y
<b>Part reference</b>													
Move	Y	n/a	Y	Y	N	Y	N	N	N	N	N	n/a	Y
Hide	N	n/a	Y	N	N	N	N	N	N	Y	Y	n/a	Y
Delete	Y	n/a	Y	Y	N	N	N	N	N	N	N	n/a	Y
Adjustable font size	Y	n/a	N	N	N	N	N	N	N	N	N	n/a	N
Global reannotate	N	n/a	Y	Y	N	N	N	N	N	Y	Y	n/a	N
<b>Library</b>													
Screen directory	Y	Y	Y	Y	N	N	Y	Y	Y	Y	Y	Y	Y
DeMorgan	N	N	Y	N	N	N	N	N	N	Y	Y	N	Y
<b>Printer Output</b>													
Fit to page	Y	Y(3)	N	N	N	N	Y	n/a	n/a	N	n/a	n/a	n/a
Border off	n/a	n/a	n/a	n/a	n/a	n/a	n/a	Y	n/a	Y	Y	n/a	n/a
Title box off	n/a	n/a	n/a	Y	n/a	n/a	n/a	Y	n/a	Y	Y	n/a	n/a
Software control	Y	Y	Y	Y	Y	Y	Y	Y	n/a	Y	Y	n/a	n/a
<b>Plotter Output</b>													
Fit to page	Y	Y	Y	N	N	N	n/a	n/a	n/a	n/a	n/a	n/a	n/a
Maximum page size (inches)	8 × 20	17 × 17	34 × 34	34 × 34	17 × 17	17 × 17	n/a	34 × 34	n/a	n/a	34 × 34	n/a	n/a
Software control	Y	Y	Y	N	Y	Y	n/a	Y	n/a	n/a	Y	n/a	n/a

1) Extra cost      2) Limited to move and change only      3) Except dot-matrix printers

viously have been pretty much mix-and-match, allowing you to assemble a circuit design package a la carte. The really serious user, however, will want an integrated package—in other words, schematic capture with linked PC board layout and forward and backward annotation. However, pricing on these programs generally starts at \$500, and quickly escalates from there. Fortunately, there are two packages that won't break your piggy bank. Here are their stories.

<b>Product:</b>	EZ-Route
<b>Version:</b>	2.2
<b>Price</b>	\$249
<b>Platform:</b>	Windows
<b>Publisher:</b>	Advanced Microcomputer Systems

It usually costs a fair chunk of change to buy netlist-linked schematic capture and PC board layout software. That's why it was delightful to find EZ-Route Std selling for just \$249. In addition to linked schematic capture and PC board layout, EZ-Route Std includes design verification and interactive error checking—plus SMD (surface-mount device) support.

Each program is separate and differs in both looks and operation. For instance, the schematic capture drawing menu lists the drawing options as wires, buses and lines, whereas the PC board layout draw menu offers tracks, pads, and lines. Each program is run as an individual application and, yes, you can run both at the same time and switch between them with Windows' task manager. Moreover, changes made in the schematic are readily recognized by the PC board layout program. This means you can essentially make modifications to the schematic on the fly as you lay out the circuit board. Best of all, each schematic can have as many as 32 pages—all of which are linked to each other and to the PC board layout program.

Unfortunately, EZ-Route Std schematics have a very busy look because the netlist references are always visible and

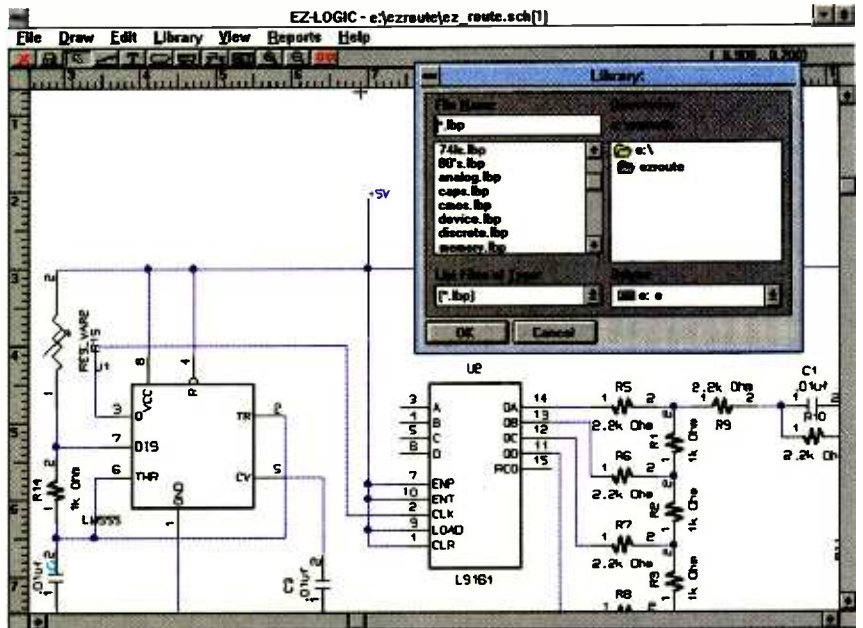


FIG. 14—WHILE THE SCHEMATIC itself is rustic and utilitarian, not of magazine quality, the link between EZ-Route's schematic capture (EZ-Logic) and PC board layout (EZ-Route) programs is fantastic.

can't be hidden. In other words, it's not something you'd want to publish (see Fig. 14). That's a shame because the program includes thousands of symbols, including DeMorgan equivalents, in a dozen libraries. While components are easily placed from an on-screen menu, you can only guess at what they will look like because nowhere—not on the screen or in the user's manual—are they pictured. You must sort through several parts before you find the ones you need. Worse yet, you can't rotate or mirror the symbol prior to placement. All editing is done afterward, and even then you can't edit a part's value. That's why a 27 kilohm load resistor was placed on the output of the op-amp instead of the 25 kilohm resistor called for. A 25 kilohm resistor could have been created and added it to the library, but that probably would be too much trouble for what should be a simple value change. Library symbols are created and modified with a separate program under a third icon.

Fortunately, the PC board layout side of EZ-Route Std is a lot stronger than the schematic capture program. Basically, AMS has put its effort into what

really counts—linking schematic capture with a hot PC board layout program. Moreover, the schematic netlist can be read by a number of major CAE applications and simula-

<b>Product:</b>	Easy-PC Pro
<b>Version:</b>	N0444
<b>Price</b>	\$349
<b>Platform:</b>	DOS
<b>Distributor:</b>	BSOFT Software

A problem with reviews that split integrated programs into separate functions is that you sometimes get a bad image of the software because of something that was said at the beginning of the series. Such is the case of Easy-PC Pro, a second-generation PC software package from the makers of Easy-PC. Essentially, Easy-PC Pro is a classy PC board layout program hooked up with squirrely front-end schematic capture software that is unappealing and hard to use. However, the program also links the schematic capture to optional analog and digital simulation programs (Analyzer III and Pulsar, respectively). In addition, will accept and convert Easy-PC schematics into netlist format for PC board layout. What you get for \$349 is the nucleus of a fairly powerful design/

test/production software package. For \$298 more (\$647 total), you get the whole package.

As expected, Easy-PC Pro has the look and feel of BoardMaker I and Easy-PC. But, like EZ-Route Std, the schematic is too busy with netlist details to provide magazine quality. And the schematic is unclear because wire connections are made accompanied by a beeping sound as you wire the diagram, rather than by the placement of the dot normally used to represent connected wires. So without a netlist, you haven't a clue as to which wires connect and which just pass in crossing.

Schematic parts are easily accessed and placed from a pull-down menu. Parts can be rotated and mirrored before and after placement, and the zoom and pan features are excellent, letting you roam as you please while placing wires or parts. Moreover, there's auto annotation and repeat parts placement. Part references and values can be moved anywhere on the drawing with a simple edit-text command. All capacitors come with a default value of 100 nanofarads, and resistors start life as 1 kilohm clones. The values can be edited before or after placement. However, it would be nice to know what the

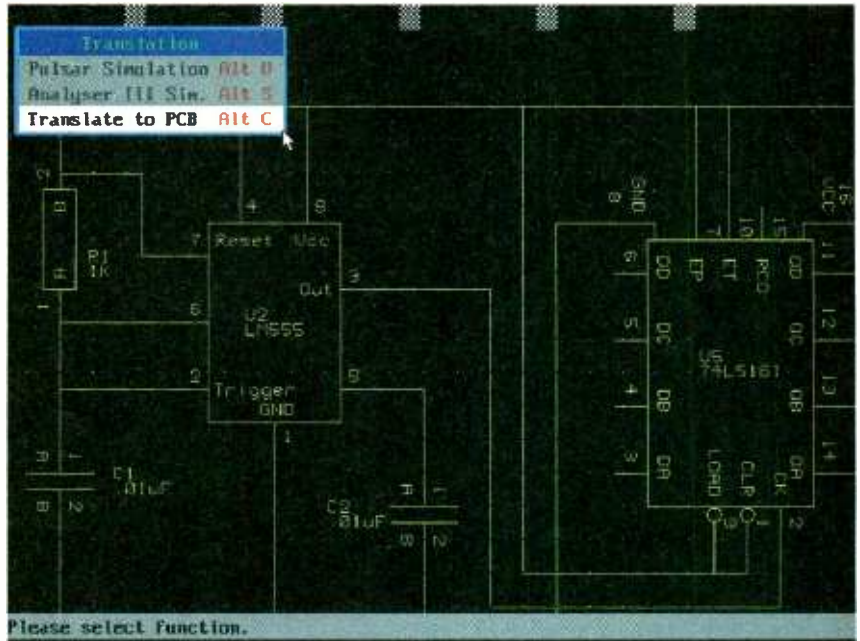


FIG. 15—WE'D BE EMBARRASSED to publish an Easy-PC Pro schematic. There are no junction dots, so you must guess which wires pass and which connect, and the netlist references are distracting.

symbol looks like before you place it (there's no chart like Easy-PC provides), because some are really poor (look at the 74LS161 chip in Fig. 15).

None of the libraries have a 555 timer, which had to be created for this project, or a variable resistor. That's because the variable resistor made for Easy-PC isn't in the same format, and making new parts for Easy-PC Pro is not an easy chore. Briefly,

you start with a library symbol editor, which provides the seed file for the generation of the schematic component and PC board components. Altogether, you wade through four editors and two files—quite an ordeal. But in the end, you have a symbol that works with all of the Easy-PC products, including the circuit simulators. Printer and file output functions are identical to those of Easy-PC.

The way Easy-PC Pro displays schematics isn't the best way, and creating new parts leaves a lot to be desired. But Easy-PC Pro does a lot more than draw schematics, and the price is right.

### Schematic summary

As you can see, these programs draw schematics that range from good to acceptable to utilitarian; Price is absolutely no indication of what to expect. On presentation quality alone, WinScheme (\$179) wins. It comes closest to the professionally drawn diagrams you find in *Electronics Now*, and it has very strong schematic editing features. CircuitMaker (\$299) places a strong second. And for the money (\$20), the quality of Schematic Plus drawings is very good. All three are Windows applications. □

### WHERE TO BUY

**BSoft Software, Inc.**  
444 Coltran Rd.  
Columbus, OH 43207  
(614) 491-0832  
CIRCLE 347 ON FREE INFORMATION CARD

**Ohio Automation**  
7840 Angel Ridge Rd.  
Athens, OH 45701  
(614) 592-1810  
CIRCLE 348 ON FREE INFORMATION CARD

**R4 Systems Inc.**  
1100 Gorman St., Suite 11B-332  
Newmarket, Ontario, Canada L3Y 7V1  
(905) 898-0665  
CIRCLE 349 ON FREE INFORMATION CARD

**MicroCode Engineering**  
1943 North 205 West  
Orem, UT 84057  
(801) 226-4470  
CIRCLE 350 ON FREE INFORMATION CARD

**BSoft Software, Inc.**  
444 Coltran Rd.  
Columbus, OH 43207  
(614) 491-0832  
CIRCLE 351 ON FREE INFORMATION CARD

**Interactive Image Technologies Ltd.**  
111 Peter St. #801  
Toronto, Ontario, Canada M5V 2H1  
(800) 263-5552  
CIRCLE 352 ON FREE INFORMATION CARD

**Advanced Microcomputer Systems, Inc.**  
1460 SW 3rd St.  
Pompano Beach, FL 33069  
(800) 972-3733  
CIRCLE 353 ON FREE INFORMATION CARD

**Mental Automation Inc.**  
5415 136th Place S.E.  
Bellevue, WA 98006  
(206) 641-2141  
CIRCLE 354 ON FREE INFORMATION CARD

**IMSI**  
1938 Fourth St.  
San Rafael, CA 94901  
(415) 454-7101  
CIRCLE 355 ON FREE INFORMATION CARD

**The Great SoftWestern Co., Inc.**  
919 South Carroll Blvd., Suite 103  
Denton, TX 76201-6869  
(817) 383-4434  
CIRCLE 356 ON FREE INFORMATION CARD

## AUDIO AMPLIFIER

*continued from page 34*

unity gain, splitting the approximately 8-volt bias generated by Q24 and applying it to the output transistor gates referenced to the power supply rails. Transistor Q24 is mounted on the heatsink to allow the bias to track the output stage temperature. Transistors Q14 and Q15 are emitter followers that drive the output transistors Q16-Q23. Finally, the output is obtained from the drains of the output transistors through relay RY1.

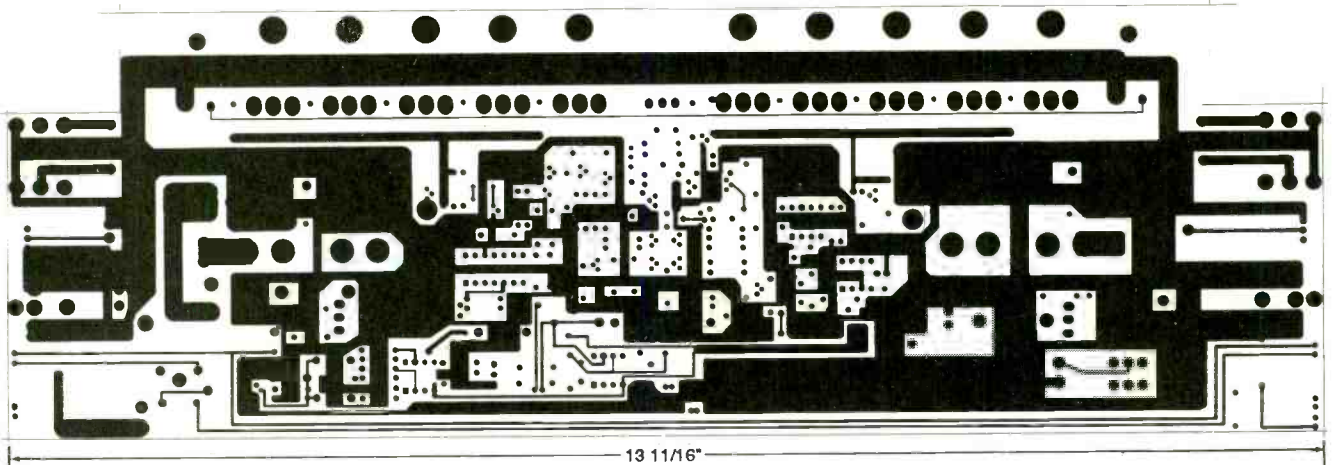
The output signal follows two feedback paths: the first is through resistor R36 to resistors R31, R32, and R35, setting the output stage voltage gain at about 30. The second feedback path, resistors R37 to

R14 and the input differential amplifier, sets the overall amplifier gain at about 29, with a closed-loop bandwidth of about 350 kHz. This completes the primary signal path from the input terminals input to the speakers.

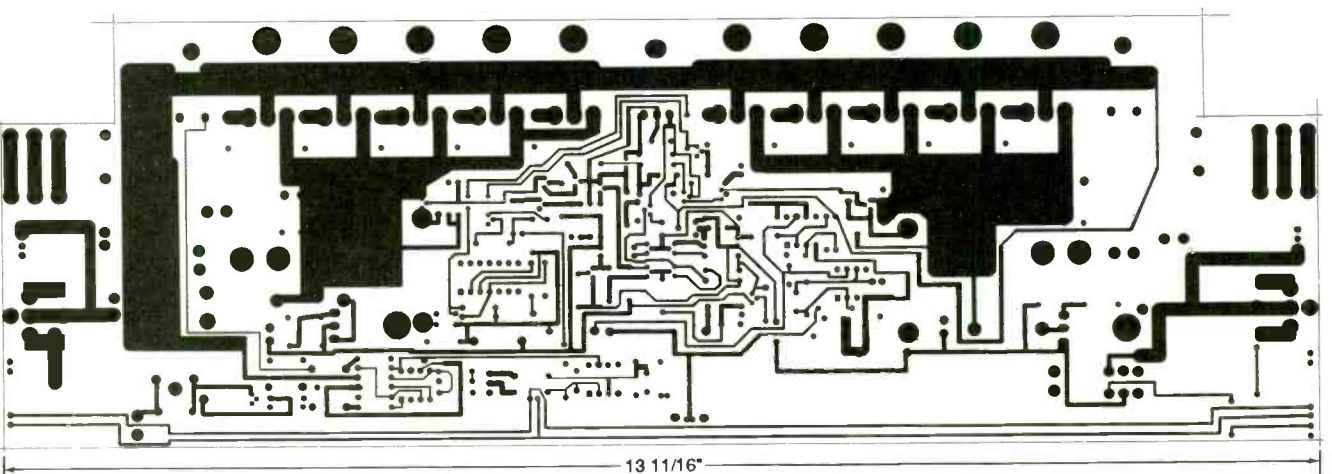
The amplifier circuit board also performs several other functions in addition to processing the audio signal. The first of these other functions is automatic servo-nulling of DC input offset voltages, performed by IC4, an LF411 JFET opera-

**TABLE 1  
AMPLIFIER SPECIFICATIONS**

Power Output: (RMS/Channel) (Both channels driven)	>300 W into 8 ohms, >600 W into 4 ohms >700 W into 2 ohms
Frequency Response:	2 Hz - 300 kHz, +0, -1 dB
Total Harmonic Distortion	<0.05% 20 Hz - 20 kHz
Slew Rate:	200 V/ $\mu$ s (typical)
Rise Time:	500 ns (typical), 600 ns (rail-to-rail)
Pulse output current capability:	>50 A into 1 ohm
Damping Factor:	>200
Signal-to-noise ratio:	100 dB, 20Hz - 20 kHz
Dimensions (case with fans)	16.5 x 14 x 3.5 inches (19-inch rack mountable)
(case without fans)	16.5 x 14 x 5.5 inches
Weight:	18 pounds



AMPLIFIER CIRCUIT BOARD PATTERN, component side.



AMPLIFIER CIRCUIT BOARD PATTERN, wiring side.

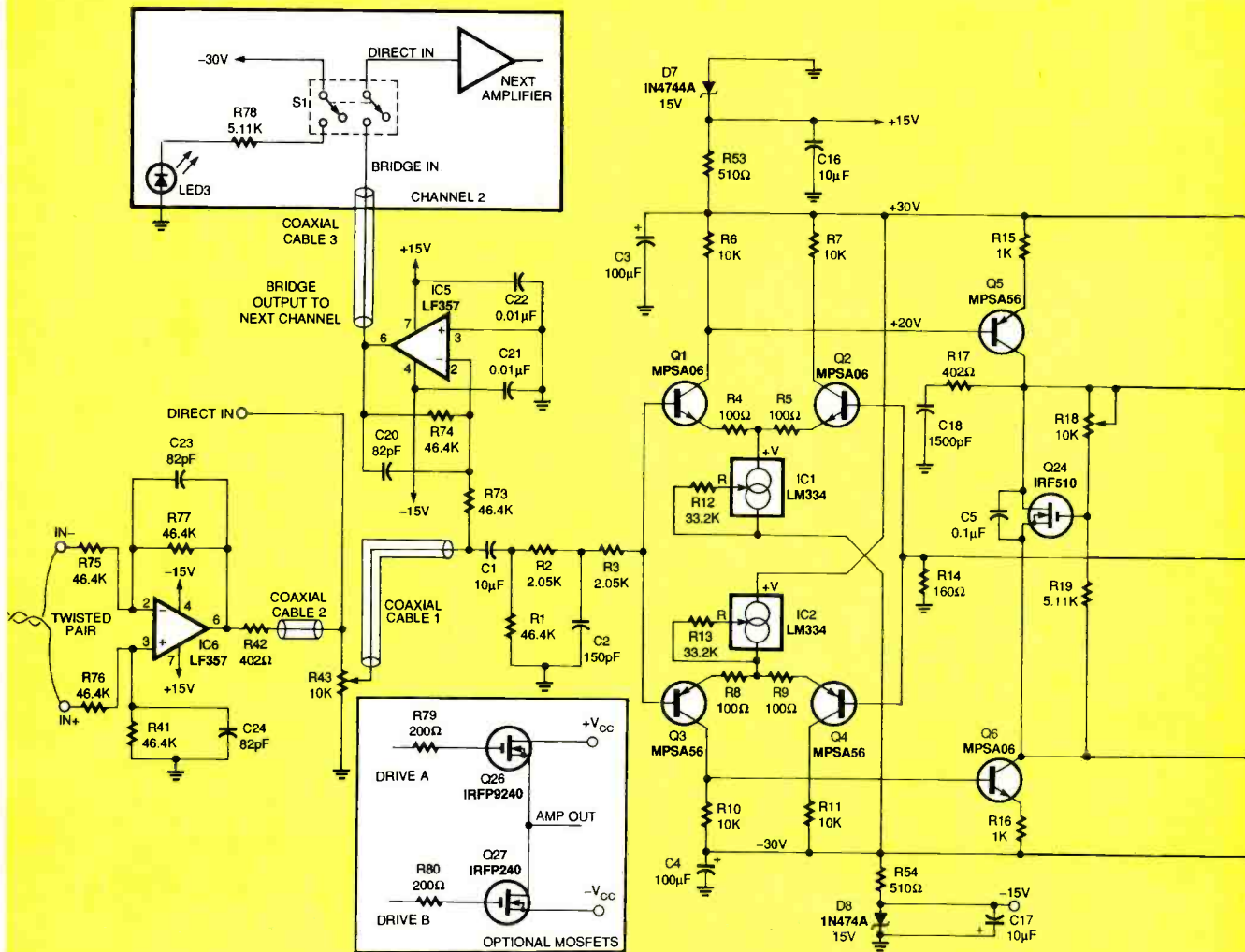


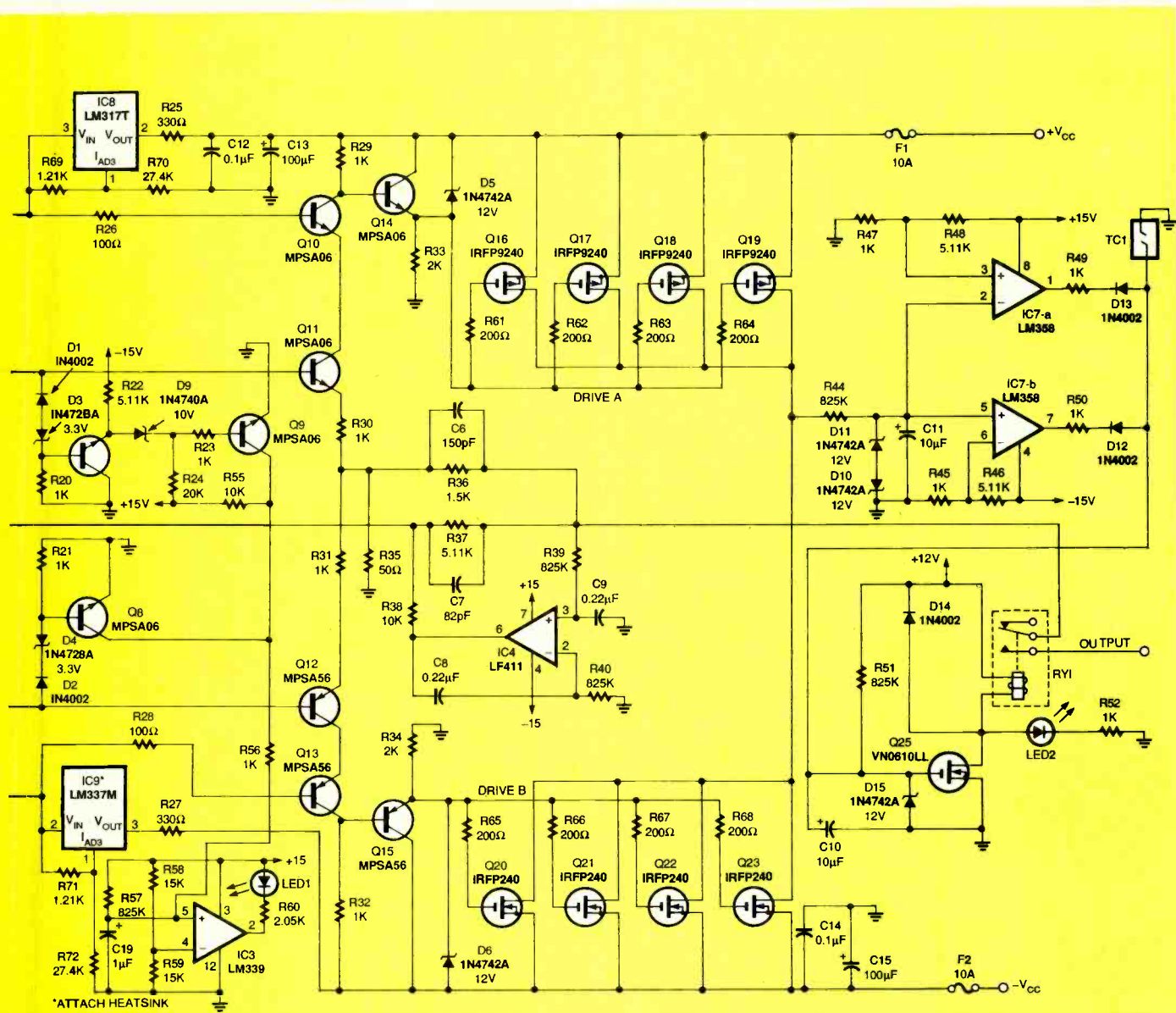
FIG. 2—SCHEMATIC FOR TWO AMPLIFIER CHANNELS. Bridge circuitry in box (upper left) shows bridging circuitry between channels.

### PARTS LIST—AMPLIFIER BOARD

All resistors are 1/4-watt, 1%, unless otherwise specified.  
 R1, R73, R74, R75, R76, R77—46,400 ohms  
 R2, R3, R60—2050 ohms  
 R4, R5, R8, R9, R26, R28—100 ohms  
 R6, R7, R10, R11, R38, R55—10,000 ohms  
 R12, R13—33.2 ohms  
 R14—162 ohms  
 R15, R16, R20, R21, R23, R29, R30, R31, R32, R45, R47, R49, R50, R52, R56—1000 ohms  
 R17—402 ohms  
 R18, R43—10,000 ohms, trimmer potentiometer, PCB mount, top adjust Clarostat 408N103  
 R19, R22, R46, R48, R78—5110 ohms  
 R24—20,000 ohms

R25, R27—330 ohms, 3 watt, 10%  
 R33, R34—2000 ohms, 5 watts, 10%  
 R35—50 ohms  
 R36—1500 ohms, 2 watts, 10%  
 R37—5110 ohms, 1/2 watt, 10%  
 R39, R40, R44, R51, R57—825,000 ohms  
 R41—46,400 ohms  
 R42—402 ohms  
 R53, R54—510 ohms, 1 watt, 10%  
 R58, R59—15,000 ohms  
 R61, R62, R63, R64, R65, R66, R67, R68, R79, R80—200 ohms  
 R69, R71—1210 ohms  
 R70, R72—27,400 ohms  
 R79, R80—200 ohms (optional)  
**Capacitors**  
 C1—10 $\mu$ F, polyester film  
 C2, C6—150 pF ceramic monolithic  
 C3, C4—100 $\mu$ F, 50 V, aluminum

electrolytic  
 C5—0.1 $\mu$ F, 50V, polyester film  
 C7, C20, C23, C24—82 pF ceramic monolithic  
 C8, C9—0.22 $\mu$ F, 50 volts polyester film  
 C10, C16, C17—10 $\mu$ F, 25 volts aluminum electrolytic  
 C11—10 $\mu$ F, 35 volts aluminum electrolytic  
 C12, C14—0.1 $\mu$ F, 100 volts polyester film  
 C13, C15—100 $\mu$ F 100 volts, aluminum electrolytic  
 C18—1500 pF ceramic monolithic  
 C19—1 $\mu$ F, 25 volts, aluminum electrolytic  
 C21, C22—0.01 $\mu$ F, 50 volts, polyester film  
**Semiconductors**  
 D1, D2, D12, D13, D14—1N4002 sil-



\*ATTACH HEATSINK

icon diode  
 D3, D4—1N4728A silicon diode, 3.3V  
 D5, D6, D10, D11, D15—1N4742A silicon diode, 12V  
 D7, D8—1N4744A, silicon diode, 15V  
 D9—1N4740A silicon diode, 10V  
 LED 1, LED 2, LED 3—light-emitting diode T-1-3/4, red or green  
 Q1, Q2, Q6, Q8, Q9, Q10, Q11, Q14—NPN transistor, Motorola MPSA06, or equiv.  
 Q3, Q4, Q5, Q7, Q12, Q13, Q15—PNP transistor Motorola MPSA56, or equiv.  
 Q16, Q17, Q18, Q19—P-channel, depletion mode MOSFET, International Rectifier IRFP9240 or equiv. (Q26 optional—see text)  
 Q20, Q21, Q22, Q23—N-channel,

depletion-mode MOSFET, International Rectifier IRFP240 or equiv. (Q27 optional—see text)  
 Q24—N-channel MOSFET, depletion mode, International Rectifier IRF510 equiv.  
 Q25—VN0610LL N-channel MOSFET switch (TO-92) Motorola or equiv.  
 IC1, IC2—LM334Z constant-current source, National or equiv.  
 IC3—LM339AN quad comparator, National or equiv.  
 IC4—LF411CN JFET input op-amp Texas Instruments or equiv.  
 IC5, IC6—LF357N JFET input op-amp, National or equiv.  
 IC7—LM358 dual low power op-amp National or equiv.  
 IC8—LM317T medium-current, three terminal adjustable positive

voltage regulator, Motorola or equiv.  
 IC9—LM337M medium current, 3-terminal adjustable negative voltage regulator, Motorola or equiv.  
**Other components**  
 F1, F2—fuse, 10 A  
 J1—jack, RCA-style  
 J2—jack, 1/4 inch Rean No. 550-20301 or equiv.  
 RY1—relay, PCB, Potter & Brumfield T90N5D12-12 or equiv.  
 S1—switch, DPDT, E-Switch TA2EECAU or equiv.  
 TC1—thermostat, 80°, Airpax 67F080 or equiv.  
**Miscellaneous (amplifier board):** amplifier circuit board, two heat-sinks for TO-220 devices, five dual screw terminal blocks, OST, Inc. No. 16 and No. 18 insulated hookup wire, solder

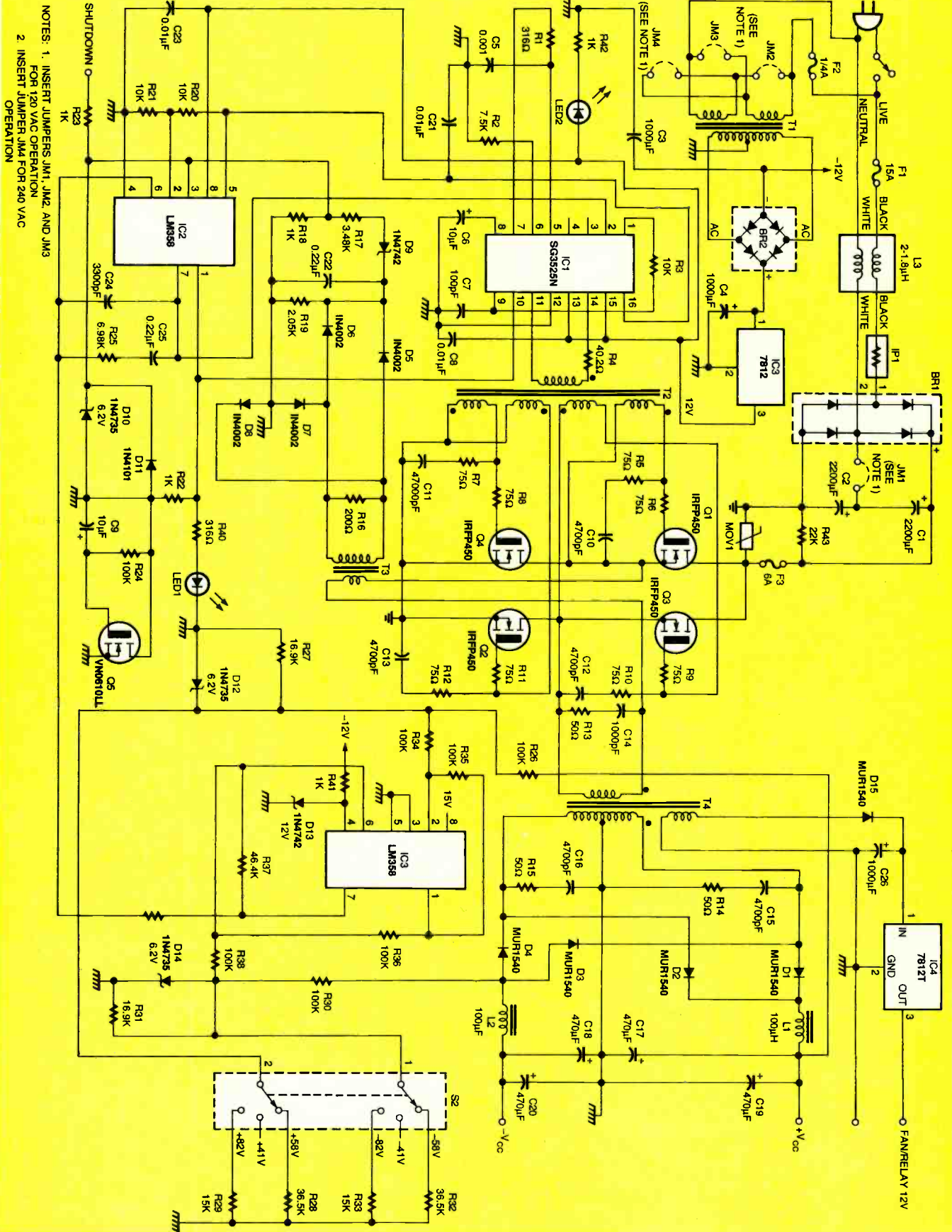


FIG. 3—SCHEMATIC FOR SWITCHING POWER SUPPLY. Circuit is a full bridge configuration that switches at 75 kHz based on four power MOSFETs.

NOTES: 1. INSERT JUMPERS JM1, JM2, AND JM3 FOR 120 VAC OPERATION.  
2. INSERT JUMPER JM4 FOR 240 VAC OPERATION.



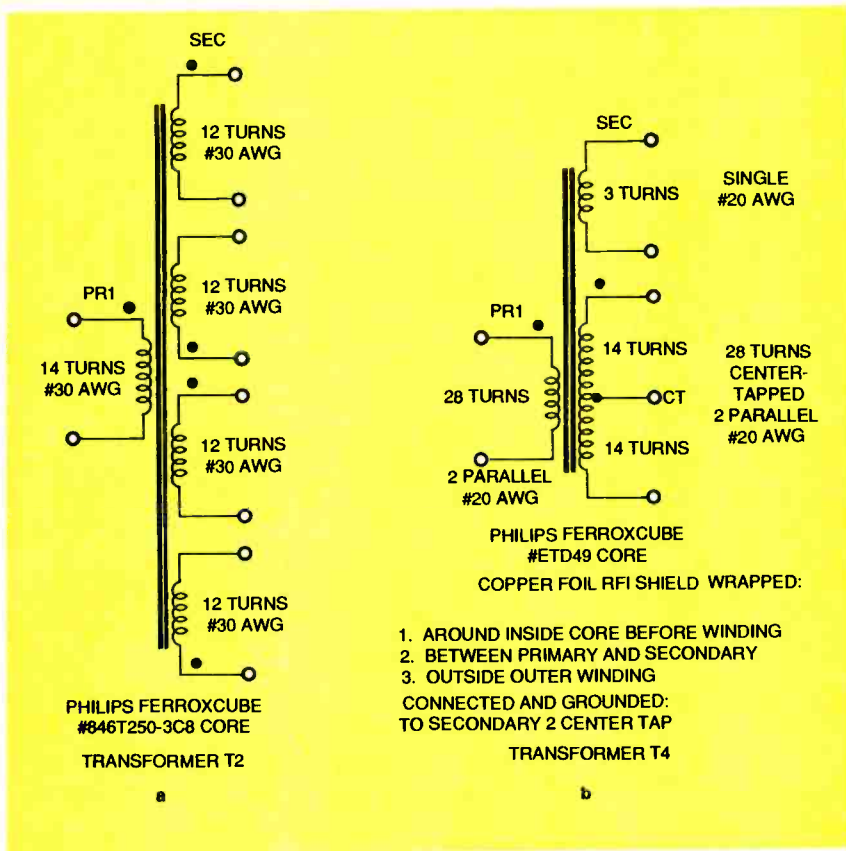


FIG. 4—TRANSFORMER WINDING INSTRUCTIONS for custom-made transformers T2 (a) and T4 (b).

tional amplifier that eliminates any DC at the output of the amplifier. This op-amp senses any DC at the output, and injects a compensating current through R38 into the feedback side of the input differential amplifier.

Next, transistors Q7 to Q9 detect amplifier clipping by sensing excessive internal drive signals that could occur when the feedback loop becomes non-linear under overload conditions. Op-amp IC3, C19, and R57 capture any clipping that occurs and light LED1 for a minimum duration of 1 second.

Both sections of IC4(a and b) detect the presence of any DC offset at the output of the amplifier, and will de-energize relay RY1 to protect the speaker. TC1 is a thermal protector, which can also de-energize RY1 if the amplifier is overheating.

Voltage regulators IC8 and IC9 maintain the supply voltage for the input stages at  $\pm 30$  volts. However, the output stage supply voltage can vary from  $\pm 41$  volts to  $\pm 82$  volts, as deter-

mined by the switching power supply setting. Diodes D11 and D12 regulate the  $\pm 15$  volts for the operational amplifiers.

### Switching power supply

Figure 3 is the schematic for the switching power supply. It is an off-line, full bridge circuit with both output current protection and shutdown capability and it offers three output voltage-setting options.

Line power input is filtered and rectified by inductor L3, full-wave bridge BR1, and capacitors C1 and C2. With jumper JM1 in place, bridge BR1 and C1 and C2 form a voltage doubler. MOSFETs Q1 to Q4 form a bridge with Q1 and Q2 and Q3 and Q4 conducting alternately in pairs. The bridge is driven by pulse transformer T2 from the SG3525N Silicon General monolithic pulse-width modulator/driver IC1. Transformer T4, the main power transformer, is driven by Q1 to Q4. Its output is rectified by fast-recovery rectifiers D1 to D4

and filtered by capacitors C17 to C20.

The positive output is divided by resistors R26 and R27. Resistor R27 is in parallel with either resistors R32 and R33, or no resistor. The feedback signal is fed to one section of the LM358 dual, low-power operational amplifier, IC3-a, acting as an inverting buffer amplifier. Its output is summed with a similar divider fed from the negative supply bus.

Operational amplifier IC3-b is an inverting summer whose gain of 0.42 is set by the ratio of the value of resistor R37 to that of R36. Zener diodes D12 and D14 ensure that neither power rail supplies more than approximately half of the 11.9 volt summed input necessary to generate the +5 volt sum output. The voltage at pin 7 of IC3-b is fed back to the pulse-width modulator comparator input pin 2 of IC1, where it is compared with the internal voltage reference applied to pin 1.

The feedback path includes a compensation network consisting of one section of an LM358 dual, low-power op-amp IC2-b, R25, C24, C25, and R39. Current in the bridge inverter is sensed by current transformer T3, whose output is rectified and filtered by silicon diodes D5 to D8 and capacitor C22. The transformer output is 2 volts for every ampere of current.

The result is compared with a fixed 2.5-volt reference by IC2-a, and if excessive current is detected, a shutdown signal is sent to pin 10 of IC1 and LED1 lights. The shutdown condition is latched through the diode D11 feedback path, until C26 charges. When C26 is charged, transistor Q5 resets the shutdown condition.

A small, low-voltage power supply consisting of transformer T1, full-wave bridge BR2 and monolithic regulator IC4 generates +15 volts to power the inverter's control circuits. Power for the 12-volt tubaxial cooling fans is obtained from a separate winding on transformer T4 after being rectified by diode D15 and regulated by voltage regulator IC4.

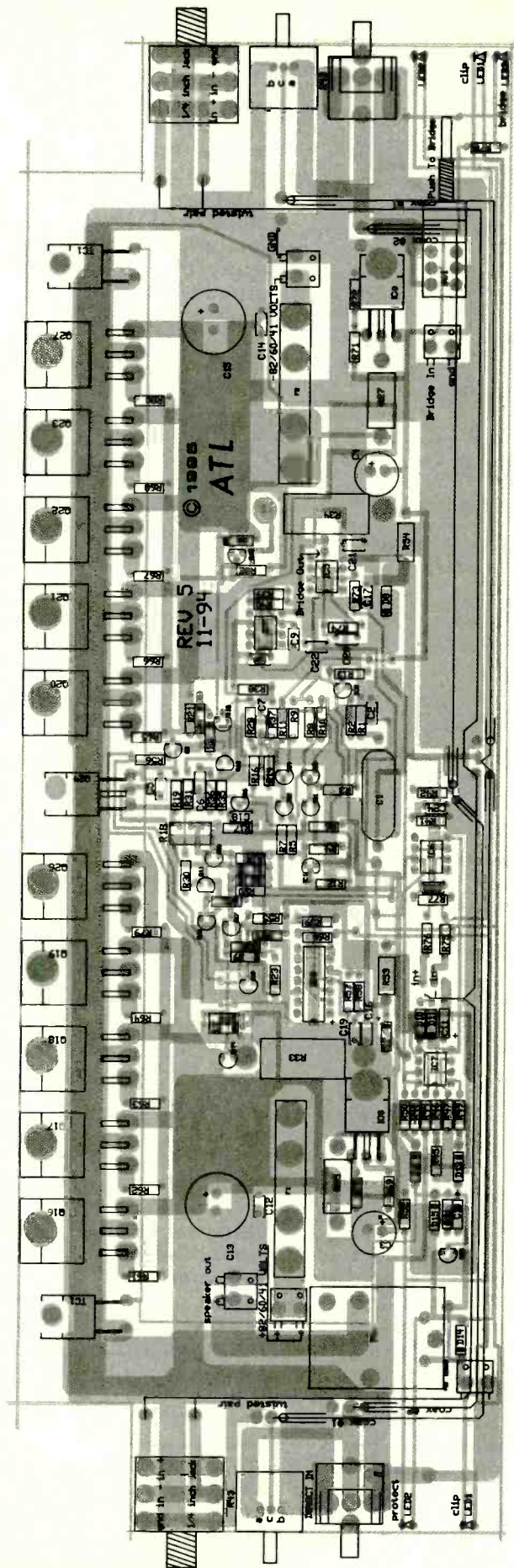


FIG. 5—AMPLIFIER PARTS PLACEMENT DIAGRAM, component side.

**Custom transformers**

Two of the transformers in the power supply, ferrite toroidal transformer T2 and ferrite E-core transformer T4 must be custom wound for this project. Refer to Fig. 4 for the winding details of these two transformers. Wind the copper foil shielding carefully on transformer T4 to prevent any short circuits with the windings. The copper foils must be wrapped so they remain "open-turn" to avoid short-circuiting transformer T4. The primary side of the transformer has 28 turns. These are to be split so that there are 14 turns on each side of the secondary.

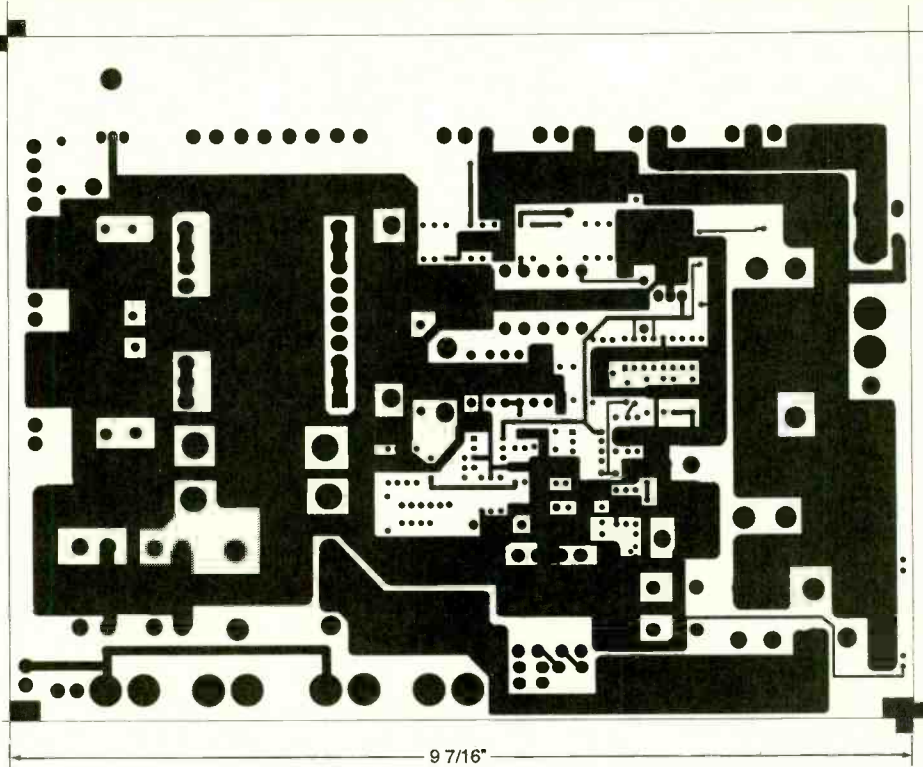
The secondary turns are to be sandwiched between the two halves of the primary turns. In other words, first wind 14 turns of the primary, then wind both

All resistors are 1/4-watt, 1%, unless otherwise specified.

- R1, R40—316 ohms
- R2—7500 ohms
- R3, R20, R21—10,000 ohms
- R4—40.2 ohms
- R5, R6, R7, R8, R9 R10, R11, R12—75 ohms
- R13—50 ohms, 10 W
- R14, R15—50 ohms, 5 W
- R16—200 ohms, 0.5 W
- R17—3480 ohms
- R18, R22, R23, R42—1000 ohms
- R19—2050 ohms
- R24, R26, R30 R34, R35, R36, R38—100,000 ohms
- R25—6980 ohms
- R27, R31—16,900 ohms
- R28, R32—36,500 ohms
- R29, R33—15,000 ohms
- R37—46,400 ohms
- R39—4990 ohms
- R41—1000 ohms, 0.5W
- R43—22,000 ohms, 10 W

**Capacitors**

- C1, C2—2200µF, aluminum electrolytic, 200 volts
- C3—1000µF, 25 volts, electrolytic
- C4—1000µF, 50 volts, electrolytic
- C5—0.001µF, monolithic ceramic
- C6—10µF, 25 volt, aluminum electrolytic
- C7—100 pF, 50 volts ceramic
- C8—0.01µF, polyester film
- C9—10µF, 25 volts, aluminum electrolytic



POWER SUPPLY CIRCUIT BOARD PATTERN, component side

**PARTS LIST—POWER SUPPLY**

- C10, C11, C12, C13,—4700pF, 50 volts, monolithic ceramic
- C14—1000 pF, 500 volts, monolithic ceramic
- C15, C16—4700pF, 500 volts
- C17, C18, C19, C20—470µF, 100 volts, aluminum electrolytic
- C21—0.01µF, 50 volts monolithic ceramic
- C22, C25—0.22µF, 50 volts, monolithic ceramic
- C23—0.01, 50 volts
- C24—3300 pF, 50 volts, monolithic ceramic
- C26—1000µF, 25 volts, aluminum electrolytic
- Semiconductors**
- D1, D2, D3, D4, D15—MUR1540 Motorola
- D5, D6, D7, D8, D11—1N4002
- D9—Zener diode, 1N4742A, 12 volt
- D10, D12, D14—Zener diode, 1N4735A, 6.2 volt
- MOV1—metal-oxide varistor Panasonic ERZ-V20D431 or equiv.
- BR1—full-wave bridge rectifier, 600 volts, 6 amperes, General Instruments KBPC3506 or equiv.
- BR2—full wave bridge rectifier, 200 volts, 6 amperes, General Instruments GBPC606CT or equiv.
- LED1, LED2—light-emitting diode, T-1-3/4 package, one red, one green
- Q1, Q2, Q3, Q4—N-channel MOSFET, depletion mode International Rectifier IRFP450 or

- equiv.
- Q5—N-channel MOSFET, depletion mode, TO-92, Motorola VN0610LLG or equiv.
- IC1—SG3525N Pulse-width modulator, Silicon General or equiv.
- IC2, IC3—LM358 dual low-power op-amp, National or equiv.
- IC4, IC5—7812, 12-volt voltage regulator, Motorola or equiv.
- Magnetics**
- L1, L2—coil 100µH, Pulse Engineering PE-92112 or equiv.
- L3—dual coil, 1.8µH Pulse Engineering PE-96188 or equiv.
- T1—low-voltage transformer, Microtran MT3137 or equiv.
- T2—drive transformer, custom wound (see text)
- T3—current transformer, Coilcraft D1871 or equiv.
- T4—power transformer, custom wound (see text)
- Other components**
- F1—fuse, 15 ampere, 250 volt, 3AG style
- F2—fuse, ¼, 250 volt, 3AG style
- F3—fuse, 6 ampere, 250 volt, 3AG style
- S2—switch, DPDT PCboard, C&K 7201P3YZQE
- IP1—inrush protector, Keystone KC001L-ND or equiv.
- Miscellaneous (power supply):** circuit board, 10 terminal blocks OST, Inc., No. 16 AWG insulated hookup wire, solder, 2 fuse clips.

**Note:** The following parts are available from A and T Labs, Box 4884, Wheaton, IL 60189

- Amplifier printed circuit board for one channel, double-sided, plated-through holes, silk screened, solder masked (two required) (K6PCB1)—\$39.00
- Switching power supply board, double-sided, plated-through holes, silk screened, solder masked (one required) (K6PCB2)—\$42.00
- Switching power supply power transformer (K6T4)—\$52.00
- Switching power supply driver transformer (K6T2)—\$15.00
- Power supply inductors L1, L2 and L3 (K6L)—\$32.00
- Heatsink set for convection-cooled case (K6HS1)—\$110.00
- Heatsink set for forced-air cooled case (K6HS2)—\$110.00
- Set of 8 matched MOSFETs for 1 amplifier channel (K6Q)—\$90.00

Add 5% U.S. or 12% Canada for shipping and handling.

Checks, money order, and VISA or Mastercard credit cards accepted. Illinois residents please add 6.75% local sales tax.

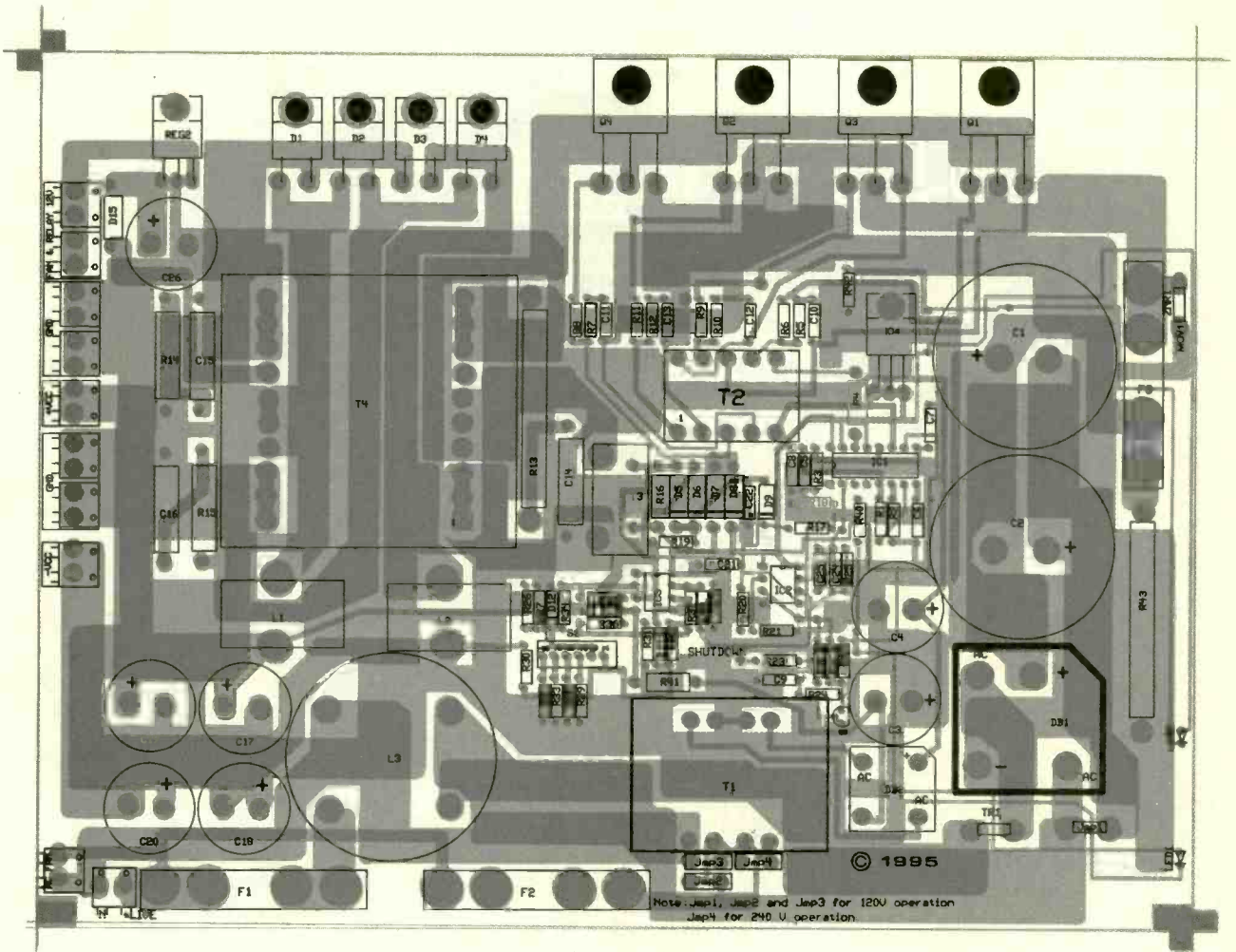
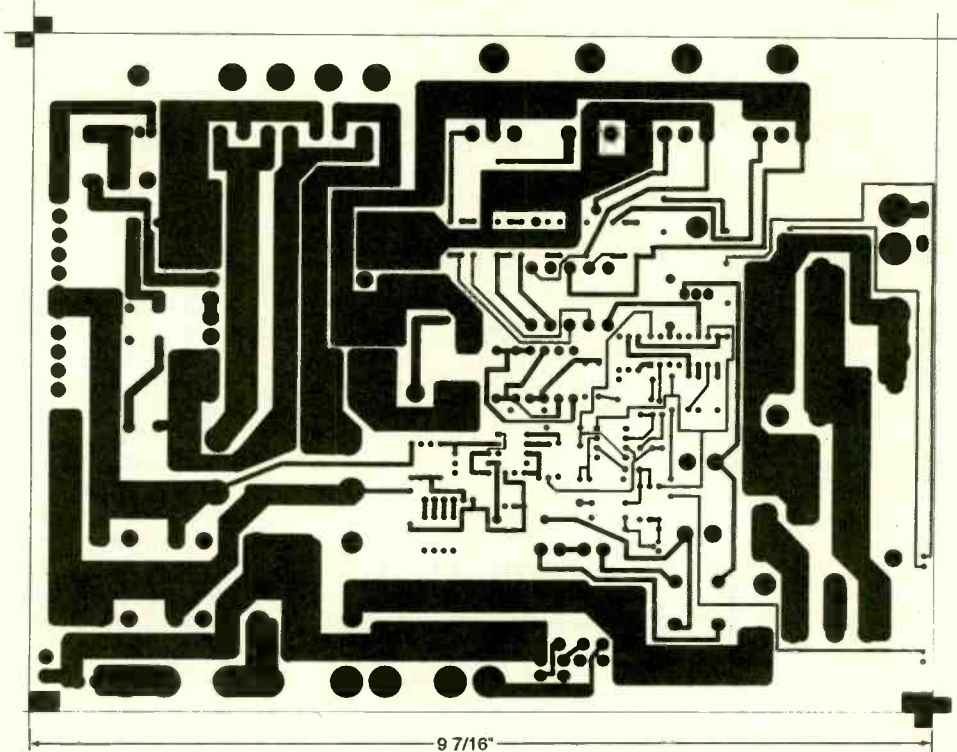


FIG. 6—POWER SUPPLY PARTS PLACEMENT DIAGRAM, component side.



9 7/16"

POWER SUPPLY CIRCUIT BOARD PATTERN, wiring side

# You can Build Gadgets!

## Here are 3 reasons why!



**BP345—GETTING STARTED IN PRACTICAL ELECTRONICS \$5.95**

If you are looking into launching an exciting hobby activity, this text provides minimum essentials for the builder and 30 easy-to-build fun projects every experimenter should toy with. Printed-circuit board designs are included to give your project a professional appearance.

**BP349—PRACTICAL OPTO-ELECTRONIC PROJECTS \$5.95**

If you shun opto-electronic projects for lack of knowledge, this is the book for you. A bit of introductory theory comes first and then a number of practical projects which utilize a range of opto devices, from a filament bulb to modern infrared sensors and emitters—all are easy to build.



**BP363—PRACTICAL ELECTRONIC MUSIC PROJECTS \$5.95**

The text contains a goodly number of practical music projects most often requested by musicians. All the projects are relatively low-in-cost to build

and all use standard, readily-available components that you can buy. The project categories are guitar, general music and MIDI.

Mail to:  
**Electronic Technology Today, Inc.**  
**P.O. Box 240**  
**Massapequa Park, NY 11762-0240**

**Shipping Charges in USA & Canada**

\$0.01 to \$5.00.....\$2.00	\$30.01 to \$40.00.....\$6.00
\$5.01 to \$10.00.....\$3.00	\$40.01 to \$50.00.....\$7.00
\$10.01 to \$20.00.....\$4.00	\$50.01 and above.....\$8.50
\$20.01 to \$30.00.....\$5.00	

Sorry, no orders accepted outside of USA and Canada. All payments must be in U.S. funds only.

Number of books ordered.

Total price of books.....	\$ _____
Shipping (see chart).....	\$ _____
Subtotal.....	\$ _____
Sales Tax (NYS only).....	\$ _____
Total enclosed.....	\$ _____

Name \_\_\_\_\_  
 Address \_\_\_\_\_  
 City \_\_\_\_\_ State \_\_\_\_\_ ZIP \_\_\_\_\_

Please allow 6-8 weeks for delivery.

secondaries. After that, continue to wind the remaining 14 turns of the primary.

Be sure to apply a small amount of epoxy or silicone adhesive in a thin layer to bond the two halves of the ferrite core to each other. They must be bonded together to prevent the ferrite "E" core from producing an audible hum. Connect the three separate foil shields and ground them to the center tap of the secondary of transformer T4.

### Building the amplifier boards

As stated earlier, both amplifier channels for this stereo amplifier are identical. Circuit boards are recommended for constructing to eliminate the tedious work of point-to-point wiring and for more reliable operation. Several features, such as bridging capability, are optional. The components related to these options will be identified in the description of the construction procedures.

The procedure that follows assumes that circuit boards are either purchased from the source given in the Parts List or the builder has either made them or obtained them from another source.

Begin amplifier board assembly by inserting and soldering all resistors, capacitors, and diodes in their specified locations, as shown on the parts placement diagram, Fig. 5. Verify the values of all components before inserting them, and be sure to identify the polarities of all diodes and electrolytic capacitors.

Next, insert and solder all small-signal transistors and ICs. Adjust trimmer potentiometer R18 to its approximate middle position. Note that transistor Q24 must be mounted later to the aluminum heatsink adapter. Install it at this time so that the transistor will be positioned at the correct distance above the board so that it can later be fastened to the angle stock with a screw and nut. A mica insulator and silicone grease will be between the MOSFET's tab and the aluminum surface.

Install the RCA input jack J1

and the level-set trimmer potentiometer R43 at the appropriate end of each channel circuit board. The clipping and protection indicating LEDs are mounted on the opposite ends of the board. If you plan to install bridging, include the bridging circuit on one of the channel boards, and switch S1 and LED 3 on the other.

For differential input capability, include the 1/4-inch jacks on the appropriate ends of the boards, as well as the twisted wire pair from the jack to the center of the board. If you do not plan to install differential input, omit the length of coaxial cable No. 2, the LM357 IC6, and the components associated with it. As the last step, install the length of coaxial cable No. 1 and the relay RY1. Do not install the output transistors Q16 to Q19 and Q20 to Q23 until after preliminary testing is completed. (This will be covered in part 2 of this article.)

### Power supply board

Refer to the power supply parts placement diagram Fig. 6 and follow the general procedure previously given for building the two amplifier channel circuit boards. Insert and soldering resistors, capacitors, and diodes first, carefully checking values and orientations. Install the small-signal transistors and integrated circuits next, followed by the transformers, the switch S1 and the fuse holders.

Bend the leads of the power transistors Q1 to Q4 and rectifiers D1 to D5 at right angles so the tabs are parallel with the circuit board but projecting outboard with a gap that will permit them to be fastened to the aluminum angle heatsink adapter. Solder them in position so that they can be aligned with the heatsink channels.

The second part of this article will cover: the selection of appropriate cases to house the configuration of your choice; the installation of the boards to the aluminum heatsink adapters; and the wiring to off-board, panel-mounted components.  $\Omega$

# The Electronics Industry is looking for a lot of good people!

Here is your chance to get in on the ground floor as an Associate CET. Is your job title "Electronics Service Technician?" Would you like to have that title? You can prove you qualify for the title with a CET Associate Certificate. It can be your career door-opener and begin your rapid advancement!

A technician or student of electronics with less than a total of four years of basic experience may take the Associate Level Exam. The exam is the basic electronics portion of the full-credit CET exam. The 75-question, multiple-choice test covers basic electronics, math, DC and AC circuits, transistors and semiconductors, instruments, measurements and troubleshooting. A successful Associate CET will receive a wall certificate valid for four years and is eligible to join ISCET as an Associate Member. ISCET is the International Society of Certified Electronics Technicians.

The ISCET Computer-Aided Associate-Level Study Guide prepares you for the Associate CET Certificate by randomly selecting sample questions with appropriate diagrams, provides multiple-choice answers, grades the test and provides a summary of your strong and weak points.

Diskette requires IBM computer or compatible with VGA color monitor, 3.5-in. drive and a hard-disk drive.

## CLAGGK INC. - CET Computer-Aided Study Guide Offer PO Box 4099, Farmingdale, New York 11735

**YES**, I want to step up to a career in servicing. Here is my order for the CET Computer-Aided Study Guide on a 3.5 diskette. I am enclosing \$39.95 (price includes shipping and handling changes) in U.S. funds.

Bill my  VISA  MasterCard Expire Date \_\_\_/\_\_\_/\_\_\_  
 USA Bank Check  US or International Money Order

Card No. \_\_\_\_\_

Signature \_\_\_\_\_

Name (Please Print) \_\_\_\_\_

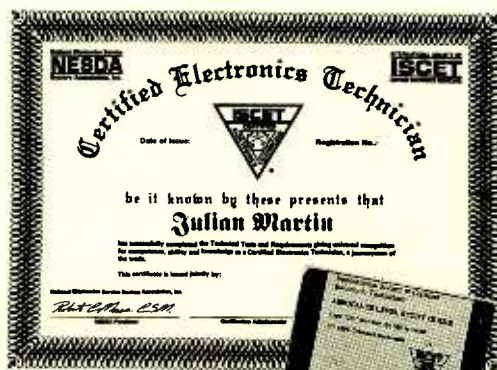
Address \_\_\_\_\_

City \_\_\_\_\_ State \_\_\_\_\_ Zip \_\_\_\_\_

New York residents add local sales taxes. Canadians add \$6.00 per order. No foreign orders. Do not send cash. Checks drawn on US Bank and International Money Orders in US funds only. Credit card users may telephone or FAX orders. Telephone 516-293-3751 or FAX 516-293-3115. Price subject to change. Allow 6 to 8 weeks for delivery.

CB06

## Proof Positive that you are a Certified Electronics Technician



## A New Computer Software Program — ISCET Computer-Aided Associate-Level Study Guide

Prepare yourself for the 75-question CET Associate Examination. Model examinations provide the technician with a study program and introduction to the actual examinations. The model examinations are automatically graded in decimal numbers and bar graphs that can be outputted on your printer. The questions for each exam are selected randomly from a loaded data base—no two exams are exactly the same. When you answer a question, the correct answer is displayed and an explanation is given. From the print-outs you will determine whether you need more practice and in which topic areas, or if you are ready to take the real test and continue to promote your electronics career today!

## POWERED SUBWOOFER

*continued from page 38*

1.2 cubic feet.

The speaker cabinet is positioned so the speaker cone faces the floor. Rails on each side of the cabinet hold it 1½-inches off the floor to create a front chamber with a volume of 0.2 cubic

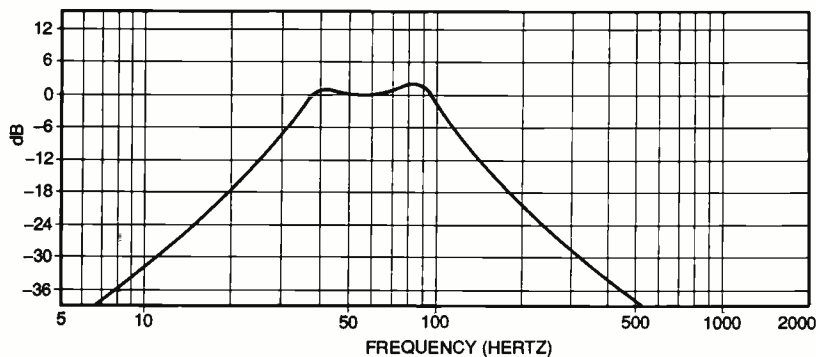
feet. The open ends created by the rails act as two ports, each measuring 1½ × 12½ inches. The frequency response of the bandpass cabinet is also shown in Fig. 3.

### Construction

The Little Earthquake crossover/amplifier circuit is built on a single-sided printed-

circuit board, which can be etched from the template provided, or purchased from the source given in the Parts List. Use the parts-placement diagram in Fig. 4 as a guide for building the circuit board. The power transistors Q3 and Q4 must be heatsinked. The transformer and circuit board are mounted on an 8½ × 4- × ¼-inch sheet of aluminum.

Figure 5 shows how to drill the heatsink plate, and Fig. 6 shows how to mount the circuit board to the plate. Transistors Q3 and Q4 are inserted and soldered from the foil side of the board and should be formed so they make contact with the heatsink when the circuit board is mounted on ¼-inch spacers. Even though the tabs of Q3 and Q4 are the collectors, which are electrically connected in the circuit, mount them to the heatsink with insulating washers and bushings anyway. By doing so, the heatsink can be earth grounded for safety. Figure 7 shows how to drill a piece of ABS plastic, measuring 8- × 2½- × ½-inch, to form a panel to mount parts on.



SPEAKER DIAMETER = 10"  
 POWER HANDLING = 70 WATTS RMS, 100 WATTS PEAK  
 IMPEDANCE = 8 OHMS  
 SPL = 94 dB  
 $F_s = 28.0$  Hz  
 $V_{AS} = 3.7$  CU.FT.  
 $Q_{TS} = 0.580$

FIG. 3—THE ENCLOSURE is a critical component of the subwoofer design. The frequency response of the bandpass cabinet is based on a 10-inch speaker with the parameters shown here.

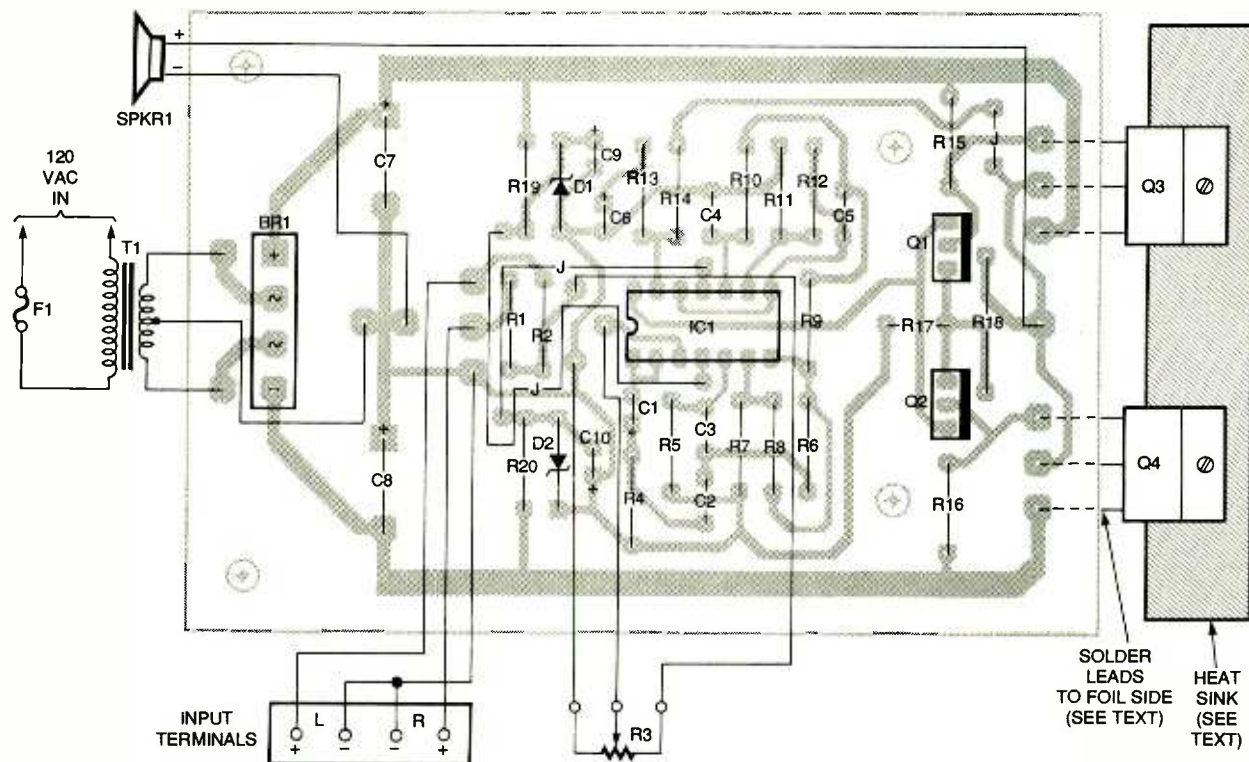


FIG. 4—PARTS-PLACEMENT DIAGRAM. Power transistors Q3 and Q4 must be heat-sinked (see text and Figs. 5 and 6).

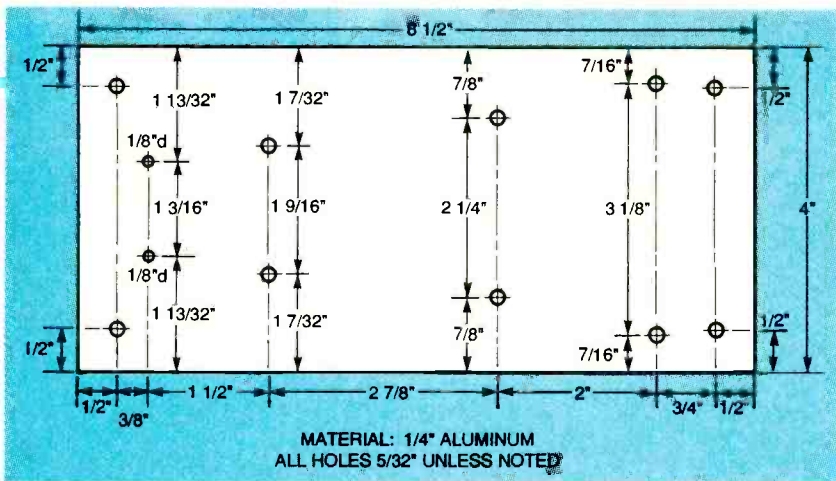


FIG. 5—DRILL THE HEATSINK PLATE (an 8½ × 4 × ¼-inch sheet of aluminum) as shown here.

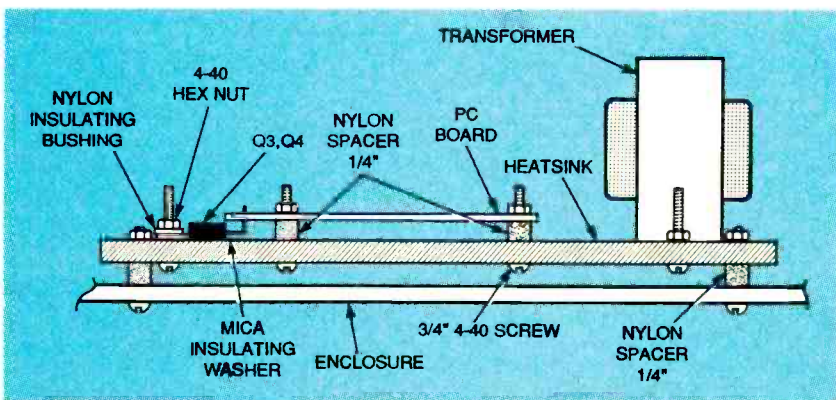


FIG. 6—TRANSISTORS Q3 AND Q4 are mounted from the foil side of the board and bent to make contact with the heatsink when the circuit board is mounted on ¼-inch spacers. Mount the transistors to the heatsink with insulating washers and bushings.

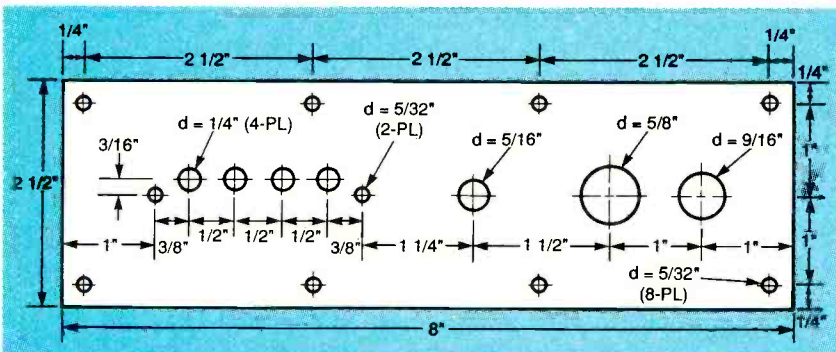


FIG. 7—DRILL A PIECE OF ABS PLASTIC, measuring 8 × 2½ × ⅛-inches, as shown here. Mount the input terminals, potentiometer R3, fuse holder, and linecord grommet on this panel.

Mount the input terminals, potentiometer R3, the fuse holder, and linecord grommet to a panel first, and then hardwire the panel to the circuit board. Then mount the panel over a rectangular cutout in the cabinet. Several tests should be made before connecting the speaker to the amplifier, so leave them disconnected for now.

### Testing

The first step is to check the power supply. Verify that ±35 volts DC is supplied to the emitters of Q3 and Q4, respectively, and that IC1 has ±15 volts DC on pins 4 and 11, respectively. Also check the DC voltage at the output (the collectors of Q3 and Q4). If there is more than 0.1 volt on the output, make sure

the components are installed correctly, especially C6. Too high a DC voltage on the output can damage the speaker.

If you have a function generator and an oscilloscope, verify the operation of the bandpass filter by connecting the function generator to the input terminal, and the oscilloscope to pin 8 of IC1. With a sinewave input signal of a few volts, perform a frequency sweep from 20 to 150 Hz or more, and verify that the output voltage on the oscilloscope follows the function shown in Fig. 2.

### Cabinet construction

The dimensions for the cabinet were determined with computer software. The software calculations showed that inside dimensions of 17 × 14 × 8½-inches would achieve the desired sound. Any rigid wood-based material can be used to make

### PARTS LIST

All resistors are ¼-watt, 5%, unless otherwise noted.

R1, R2, R5, R6, R9, R10, R14—47,000 ohms

R3—1000 ohms, panel-mount potentiometer

R4—7500 ohms

R7, R11, R15, R16—10,000 ohms

R8, R12—15,000 ohms

R13—1000 ohms

R17—56 ohms, 2-watts

R18—180 ohms, 2-watts

R19, R20—2000 ohms

### Capacitors

C1—1 μF, 35 volts, electrolytic

C2, C3—0.1 μF, mylar

C4, C5—0.047 μF, mylar

C6, C9, C10—47 μF, 35 volts, electrolytic

C7, C8—3300 μF, 50 volts, electrolytic

### Semiconductors

BR1—Bridge rectifier, 4 amps, 100 PIV (KBL01 or equivalent)

D1, D2—1N4744 15-volt Zener diode, 1 watt

Q1—TIP111 NPN Darlington transistor

Q2—TIP116 PNP Darlington transistor

Q3—TIP34B PNP power transistor

Q4—TIP33B NPN power transistor

IC1—TL074 quad op-amp

### Other components

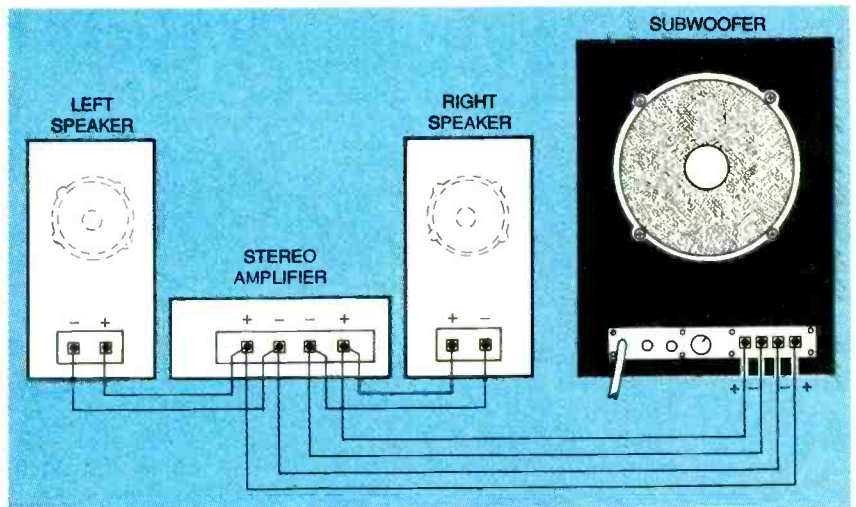
T1—120-to 48-volt centertapped



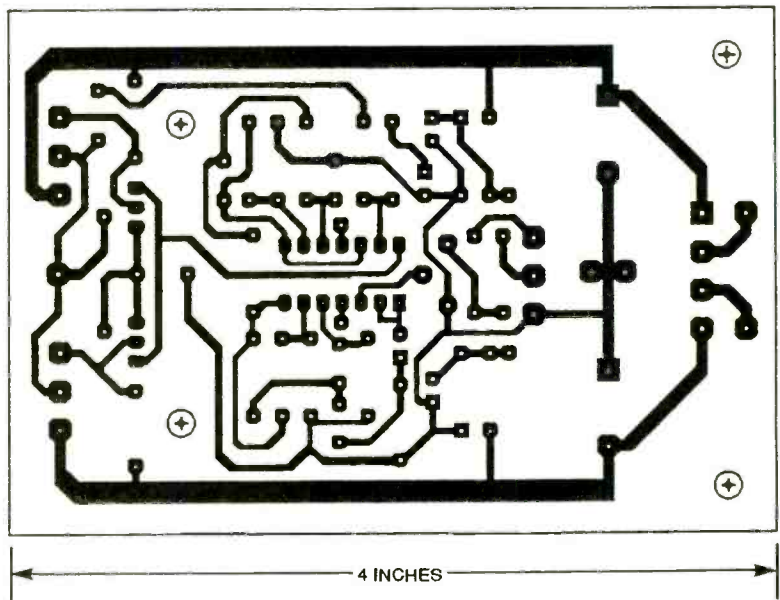


**FIG. 8—**CUT A 9-INCH DIAMETER HOLE in the bottom panel for the speaker and make a 7- × 1½-inch cutout for the control panel. Rails formed from 1- × 2-inch furring strips are glued to the bottom panel to hold the subwoofer above the floor.

the cabinet, as long as the inside dimensions remain the same. The prototype cabinet



**FIG. 9—**IT IS VERY IMPORTANT that the subwoofer be connected properly to the stereo amplifier, or else the amplifier can be damaged.



**FOIL PATTERN** for the amplifier/crossover board.

- transformer, 1.2 amps  
 F1—1-amp fuse  
 SPKR1—8-ohm, 10-inch speaker  
**Miscellaneous:** PC board, line cord and strain-relief bushing, panel-mount fuse holder, 4-position spring terminals, knob for R3, 8½ × 4- × ¼-inch aluminum heatsink plate, 8- × 2½- × ⅛-inch ABS plastic for control panel, hardware, nylon spacers, wire, assembled speaker enclosure with 17- × 14- × 8½-inch inside dimensions.

**Note:** The following items are available from Lynn-Eren Electronics, 17093 SW Lynnly Way, Sherwood, OR 97140, 503-625-2205:

- Complete kit including speaker, assembled cabinet, and all parts—\$169
- Assembled and tested subwoofer unit—\$199
- Drilled heatsink plate and plastic control panel—\$20
- PC board only—\$15

Check, money order, VISA, and MasterCard are accepted. Add \$10 S&H to orders that include cabinets or speakers. All cabinets are supplied unpainted.

was constructed from ¼-inch birch veneer plywood with 1- × 1-inch furring strips for reinforcement along every inside seam.

The bottom panel, which holds the speaker and control panel, was made from ½-inch particle board for added strength. A 9-inch diameter hole was cut out of the bottom panel for the speaker, and a 7- × 1½-inch cutout was made for the control panel. Rails to hold the subwoofer unit above the floor were formed from 1- × 2-inch furring strips glued to the long edges of the bottom panel. Glue and screw every seam of the cabinet and seal the seams

inside with silicone caulking. Solid construction of the cabinet will prevent annoying rattling and buzzing noises while the subwoofer is operating. Figure 8 shows the underside of the completed cabinet. For those who prefer to avoid woodworking, an assembled and sealed cabinet is available from the source given in the Parts List.

#### Final assembly

Install the speaker last so that the speaker mounting hole can provide access to the inside of the cabinet to install the heatsink assembly and control panel. Securely fasten the control

panel to the cutout in the bottom panel of the cabinet with eight No. 6 screws to prevent it from vibrating. Mount the heat-sink/PC board assembly to the side panel of the cabinet adjacent to the control panel with four No. 6 screws and ¼-inch nylon spacers. The spacers allow air to pass underneath the heatsink. Once the control panel and heatsink assembly are installed, the speaker can be mounted. If the speaker buzzes or rattles, it should be sealed to the enclosure with silicone caulking.

### Installation and use

Place the completed subwoofer somewhere in the listening room where the input wires and power cord can be concealed. A wiring diagram is shown in Fig. 9. It is very important that the subwoofer be connected properly to the stereo amplifier.

With the power off and the speakers disconnected from your stereo, place an ohmmeter across the negative terminals of your stereo amplifier. If the terminals are not shorted together, or if your stereo amplifier is operated in mono-bridged mode, connect only one input. The negative terminals of the subwoofer are shorted together to ground. Connect the negative terminals of your stereo amplifier to the negative terminals of the subwoofer. Your stereo amplifier will almost certainly be damaged if its positive output terminals are short-circuited together.

When the input connections are made, turn the volume knob down all the way and plug the subwoofer into an AC outlet. Adjust the volume on your stereo, then adjust the subwoofer volume. If you have tone controls on your stereo, fine-tune the subwoofer volume by adjusting the bass control on your stereo system.

With the Little Earthquake subwoofer, you can discover the world of sound and suspense hidden deep in the audio spectrum. Listen again to all of those great movies, and feel them at home for the first time! Ω

## WHAT'S NEWS

*continued from page 4*

cuit, but the willingness of the broadcasters and cable operators to transmit the required identifying signal.

As envisioned, the television stations would transmit a special rating code with each program, designating whether the program contained violence, nudity, offensive language, or is otherwise unsuitable for children. The code would be carried in an unused part of the television signal—the black bar between each frame of video. (This is the same bar that appears when the horizontal hold on a TV set is faulty and the picture scrolls.)

The V-chip, when installed in a TV receiver or cable converter, would read the signal. Provision would be made for parents to program the IC to blank out specific programs or even whole channels. However, it will be possible to block only the video portions but not the audio that could contain vulgar or offensive language. An electronics industry group has proposed signal standards, but broadcasters and cable operators have not yet agreed on a rating system that the V-chip would interpret.

## 21st century semiconductor modeling tools

The U.S. government has not given up on trying to give a boost to American semiconductor manufacturers. The Semiconductor Research Corporation (SRC) and three U.S. Department of Energy (DOE) laboratories have begun work under a \$100-million agreement aimed at preserving what they say is the U.S. lead in manufacturing semiconductors.

The objective of the cooperative research and development agreement (CRADA) is to stimulate U.S. competitiveness by improving the industry's ability to model and simulate semiconductor materials, devices, systems, and manufacturing processes.

The semiconductor market will continue to demand increased device performance, at higher densities at

reduced costs. To remain competitive, semiconductor manufacturers must develop fundamentally new models of solid-state and atomic physics.

The development of modeling tools is critical because integrated-circuit manufacturing technology has outpaced the ability to model semiconductor components, a spokesman for SRC said. He added that the cost and complexity of making integrated circuits has reached a point where advanced modeling and simulation tools are an imperative.

University researchers working with the SRC have shown that computer-aided design tools would dramatically reduce the cost and time required to develop each new device generation. The cooperative research program will be conducted at Los Alamos, Sandia, and Lawrence Livermore national laboratories, in collaboration with researchers at SRC member companies.

The SRC, based in North Carolina, is a consortium of more than 60 semiconductor companies and government agencies that plans and implements an integrated program of pre-competitive research. SRC members and the DOE each will contribute \$10 million a year for five years.

The CRADA includes work in five areas: (1) development of new moving, adaptive computational algorithms for modeling complex three-dimensional device structures and their manufacturing processes; (2) development of a combined equipment/wafer simulator that will describe how surface topography is affected during deposition and etch processes; (3) improved simulation tools to predict the behavior of electrons in semiconductors; (4) improved methods to predict failure in electronic contacts or interconnects based on microscopic grain characteristics; and (5) predictive codes for such semiconductor manufacturing processes as ion implantation and impurity diffusion.

The agreement is an important step on the National Technology Roadmap for Semiconductors. It was developed in 1994 by the Semiconductor Industry Association as a common vision for semiconductor technology for the next 15 years. EN

## NEW PRODUCTS

*continued from page 23*

### DIGITAL MULTISYSTEM VIDEO CONVERTER

THE TR-10 DIGITAL MULTISYSTEM video converter from Ten Labs accommodates NTSC, PAL, and SECAM inputs, and converts them to NTSC or PAL outputs. When paired with a PAL player-recorder, the converter permits foreign tapes to be played back on a standard U.S. monitor, PAL tapes to be copied into



CIRCLE 26 ON FREE INFORMATION CARD

NTSC, or American-standard tapes to be dubbed into PAL.

The TR-10 includes built-in time-base corrector, a digital line and field video processing/conversion, two megabytes of field memory, automatic gain control, and an auto-detecting system mode.

The TR-10 video converter is priced at \$595.00

#### TEN-LAB

2217 Malcolm Avenue  
Los Angeles, CA 90064  
Phone: 310-474-6909  
Fax: 310-441-1807

### WATER-TOLERANT PRESSURE SENSOR

THE MPX906D PRESSURE sensors from Motorola are 6-kPa, sili-



CIRCLE 27 ON FREE INFORMATION CARD

con piezoresistive devices. They are compatible with water, water vapor and other wet environments without protective membranes. The low-pressure sensors are said to offer accurate linear voltage output corresponding to more than 24 inches of water, full-scale pressure range.

The MPX906D pressure sensors are priced at \$6.50 each in small quantities.

#### MOTOROLA, INC.

Sensor Marketing—MD Z208  
5005 East McDowell Road  
Phoenix, AZ 85008  
Phone: 602-244-4556  
or 1-800-273-6731

### MINI DC/AC CLAMP METER

THE MODEL 380915 1000 ampere, industrial grade clamp meter from Extech Instruments measures AC and DC volts, current, and resistance. Its ranges are 200 volts DC with 0.1-volt resolution, 500 volts AC with 1-volt resolution; 200 and 1000 AC or DC amperes with 0.1-ampere resolution; and 200 ohms with 0.1-ohm resolution.

The meter measures 7.1 × 1.9 × 1.4 inches and its jaw has an opening of



CIRCLE 28 ON FREE INFORMATION CARD

1.2 inches. It has a 3½-digit, 0.5-inch high liquid crystal display. The 380915 can perform data hold, and it has overload protection with indication, and automatic polarity. It meets the IEC 348 safety requirements and has a test socket fuse for safety. The clamp meter is sold with a carrying case, test leads, and battery.

The Model 380915 DC/AC mini-clamp meter is priced at \$159.00

#### EXTECH INSTRUMENTS

335 Bear Hill Road  
Waltham, MA 02154-1020  
Phone: 617-890-7440  
Fax: 617-890-7864

## ELECTRONIC KITS AND MORE!



**World's Smallest Crystal Controlled Transmitter Kit**  
Up to 1/2 mile range  
Uses board mount 3V battery  
Transmits at 143.79 MHz  
XTL1000 E-Z .....\$69.95

**Micro-Minature FM Transmitter Kit**  
Up to 1/2 mile range  
Uses board mount 3V battery  
Transmits from 88 to 108 MHz  
XWB1000 E-Z .....\$49.95



**World's Smallest FM Transmitter kit**  
Up to 1 mile range  
Uses 9V battery/Transmits from 88 to 108 MHz  
XST500 E-Z .....\$44.95

For Catalog and Orders Call 1-800-336-7389  
We accept Check, MO, MC/VISA and COD. S&H Extra  
Send Mail Orders To:  
**XANDI ELECTRONICS, INC.**  
1270 E. Broadway Rd. #113 Tempe, AZ 85282

## CABLE CONVERTERS CABLE DESCRABLERS CONVERTER TEST CHIPS

WIRELESS QUICK BOARDS IN STOCK  
SCIENTIFIC ATLANTA - ZENITH-TOCOM  
PIONEER-JERROLD COMPATIBLE-OAK  
30 DAY MONEY BACK GUARANTEE

WE SHIP FEDERAL EXPRESS & UPS COD 2DAY AIR  
#1 IN CUSTOMER SERVICE & PRODUCT SUPPORT  
VISUAL COMMUNICATIONS INC.  
615 MAIN ST. SUITE 206 STROUDSBURG PA 18369  
1-800-GO-CABLE  
FOR CATALOG CALL 717-620-4363 NO PA. SALES

**CABLE TV CHANNELS**

EQUIPMENT Direct!

**GUARANTEED**

SAVE \$1000's

The Nationwide source for cable TV equipment.

"BUY WHERE THE DEALERS BUY."

**FREE** TV Cable Descramblers, Converters and Magic Box Catalog. Open Every Day!

**FREE** Your VCR TAPES CAN PLAY AS CLEAR AS DAY! Eliminates copy protection on any tape.

UNLEASH NOW WITH Video Decoder

Copy any rental/bought tapes  
Power Cord and RC Plug Included

2 Year Warranty

**CALL NOW!**

Member Seller: Business Bureau

**MEGA ELECTRONICS**

1-800-676-6342

FREE 30 Day Trial!

VISA • MC • COD

## SUBWOOFER

*continued from page 42*

tioned in the Parts List. The board is designed to accommodate two different crossover circuits. This article is written about only one of them. That is why many of the pads on the board are unpopulated. Mount Potentiometer R13 in a socket so that its height from the board equals those of the bodies of the switches. That way it can project through an opening in the cover of the case and be adjusted with the case cover in place.

Be sure that all electrolytic capacitors, especially C10 and C11, are rated for operation at 105°C. Electrolytic capacitors rated at 85°C will deteriorate to a lower capacitance value after a few years of operating in high-temperature automotive environments.

The prototype crossover board provides two RCA output jacks (J1 and J2) for connecting the mono subwoofer signal to both inputs of a stereo amplifier. The jacks included with the kit mount on the underside of the board in holes drilled especially for them. The electrical connections to the jacks are made on the top of the board by soldering the jack leads to the two wire jumpers that span the board. This can be seen in the

## PARTS LIST

All resistors are 1/8-watt, 5%, unless noted.

R1-R4—47,000 ohms  
 R5, R6, R19, R21—10,000 ohms  
 R7—20,000 ohms  
 R8—16,000 ohms  
 R9—3300 ohms  
 R10, R11—9100 ohms  
 R12, R14, R16, R23—2200 ohms  
 R13—10,000 ohms, linear taper potentiometer  
 R15—100,000 ohms  
 R17—5100 ohms  
 R18—1000 ohms  
 R20—47 ohms  
 R22—18,000 ohms

### Capacitors

C1, C2—0.22  $\mu$ F, Mylar  
 C3—0.047  $\mu$ F, Mylar  
 C4, C6, C7—0.1  $\mu$ F, Mylar  
 C5—0.01  $\mu$ F, Mylar  
 C8, C9—0.22  $\mu$ F, Mylar  
 C10—1  $\mu$ F, 25 volts, radial electrolytic, 105 degrees C  
 C11, C13—10  $\mu$ F, 25 volts, radial electrolytic, 105 degrees C  
 C12—220  $\mu$ F, 25 volts, axial electrolytic

### Semiconductors

Q1, Q3-Q5—2N3904 NPN transistor  
 Q2—2N3906 PNP transistor  
 D1, D2—1N914 diode

IC1—MF4CN-100 switched capacitor filter

IC2—78L08 voltage regulator

### Other Components

S1—DPDT switch

S2—SPST switch

J1, J2—RCA jack, PC mount

**Miscellaneous:** PC board, project case, hardware, 18 AWG stranded wire

**Note:** The following items are available from MFR Engineering, 10308 Indian Lake Blvd S., Indianapolis IN 46236:

- Crossover PC board (drilled and plated)—\$10

- PC board and IC1 and IC2—\$14

- PC board and all electrical components including switches and jacks—\$29

- Complete kit of all parts (includes PC board, all parts, and project case)—\$39

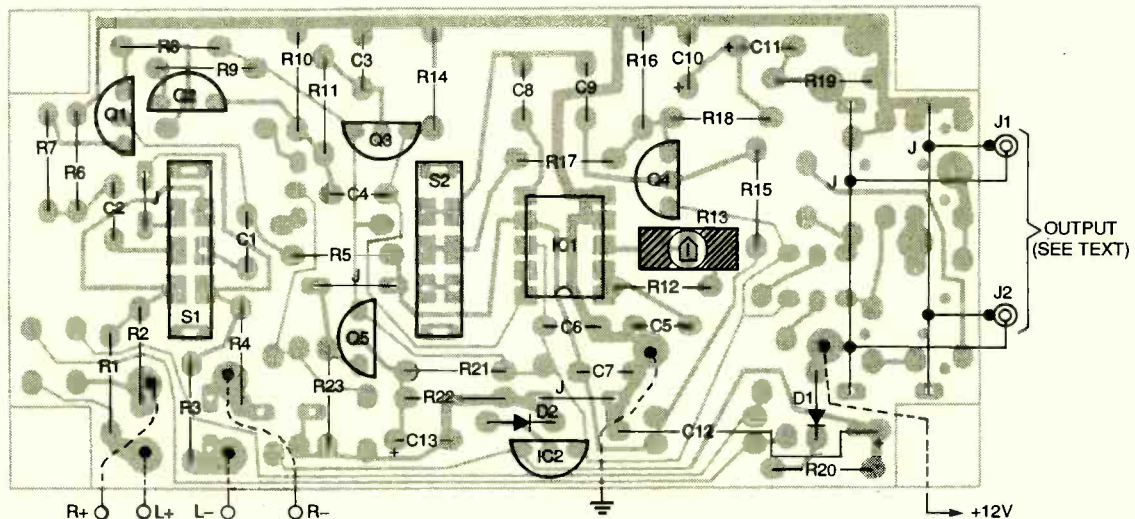
- Assembled and tested crossover unit—\$59

Shipping and handling is included in all prices (Continental U.S.). Certified or cashiers checks, money orders, and personal checks accepted. (Shipping will be delayed until personal checks clear.)

photo of the board shown in Fig. 4.

Make the input and power connections to the crossover board by soldering 10-inch wire leads to the pads on the underside of the board as shown in

Fig. 3. Solder the leads to the board after the board is fully populated. The PC board is designed to fit perfectly in the case available from the source given in the Parts List. The case is supplied predrilled for the RCA



**FIG. 3—PARTS-PLACEMENT DIAGRAM** for the crossover PC board. The board is designed to accommodate two different crossover circuits; That's why many parts appear to be left out.

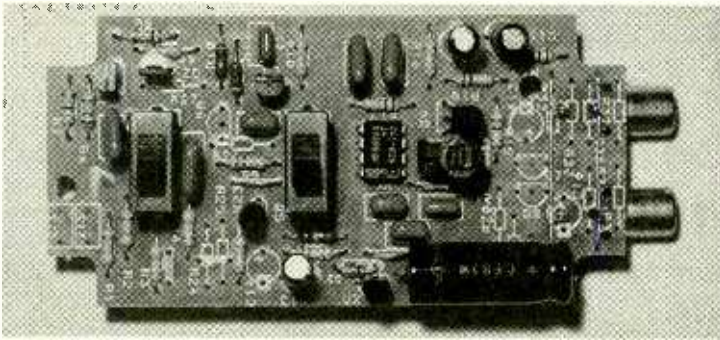


FIG. 4—PROTOTYPE CROSSOVER BOARD. The two RCA output jacks are mounted on the underside of the board, and the electrical connections are made by soldering the jack leads to the two wire jumpers that span the board.

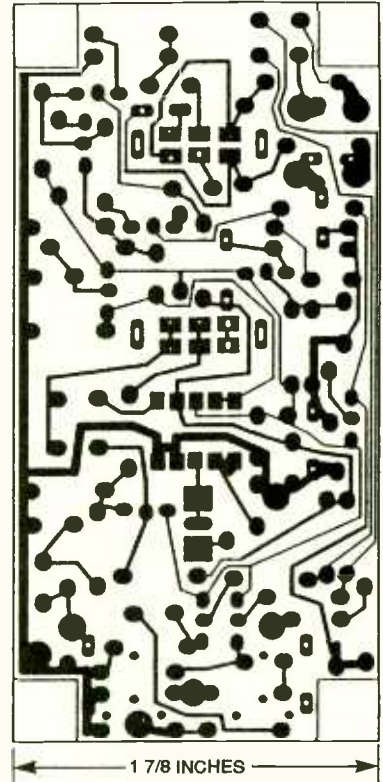


FIG. 5—THE BOARD IS HELD IN PLACE by the RCA jacks on one end. The other end of the board rests on the grommet. The case cover holds the board down by pressing on the switch bodies.

jacks and includes a rubber grommet for the input and power leads.

The board is held in place in the case by the RCA jacks on one end. The other end of the board rests on the grommet. The case cover holds the board down by pressing on the bodies of the switches.

After checking your soldering, pass the input and power leads through the single opening in one end of the case, fit the RCA jacks through the openings on the other side of the case, and push the board down into place. Pull any excess wire out of the case before installing



SUBWOOFER CROSSOVER foil pattern shown full size.

TABLE 1

	Lower Limit	Upper Limit	Units
<b>Test 1:</b> Supply Current • Measure power supply current	7	12	mA
<b>Test 2:</b> Output Level • Verify that output is sinusoidal • Measure output level	.80	.90	VRMS
<b>Test 3:</b> Polarity Switch • Change polarity switch to up position • Measure output level change	-.05	+.05	VRMS
<b>Test 4:</b> Frequency Response • Change signal frequency to find lower -3 dB frequency	19	23	Hz
<b>Test 5:</b> Equalization Frequency • Set Eq. switch to boost position • Change signal frequency to find peak frequency	37	44	Hz
<b>Test 6:</b> Equalization Boost • Set Eq. switch to flat position • Measure output level decrease	4	6	dB
<b>Test 7:</b> Filter Range • Set signal frequency to 50 Hz • Rotate pot fully CCW • Measure output level change	-7	-3	dB
<b>Test 8:</b> Regulator Dropout • Monitor DC at 8.6V regulator output, TP7 • Reduce power supply until DC decreases .1V • Measure power supply voltage	10.5	11.7	VDC

the grommet. Figure 5 shows what the assembled case looks like.

### Crossover test

The following test procedure will thoroughly check the operation of the subwoofer crossover before installation. Test points are shown in the schematic in Fig. 2.

As an initial setup, apply 15 volts DC to TP5 and ground TP6. Apply a 3-volt RMS, 130-Hz signal the left and right inputs (TP1-TP4). Ground the low side of the signal source. The output impedance should be about 600 ohms. Set potentiometer R13 fully clockwise and open switch S2. The polarity switch (S1) should be in the "down" position. Monitor the output signal at TP8 with an oscilloscope, and follow the instructions given in Table 1.

### Amplifier

A 2 × 18-watt automotive stereo amplifier will provide a good match for original equipment factory or aftermarket stereos and provide the best price/

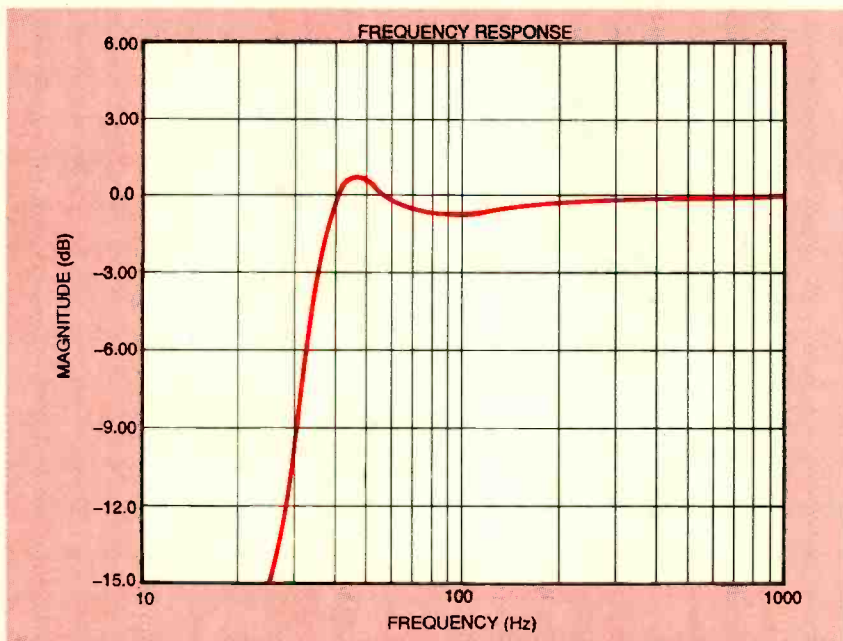


FIG. 6—COMPUTER-GENERATED FREQUENCY RESPONSE CURVE of the Madisound 81524DVC speaker in a 1.25 cubic foot enclosure.

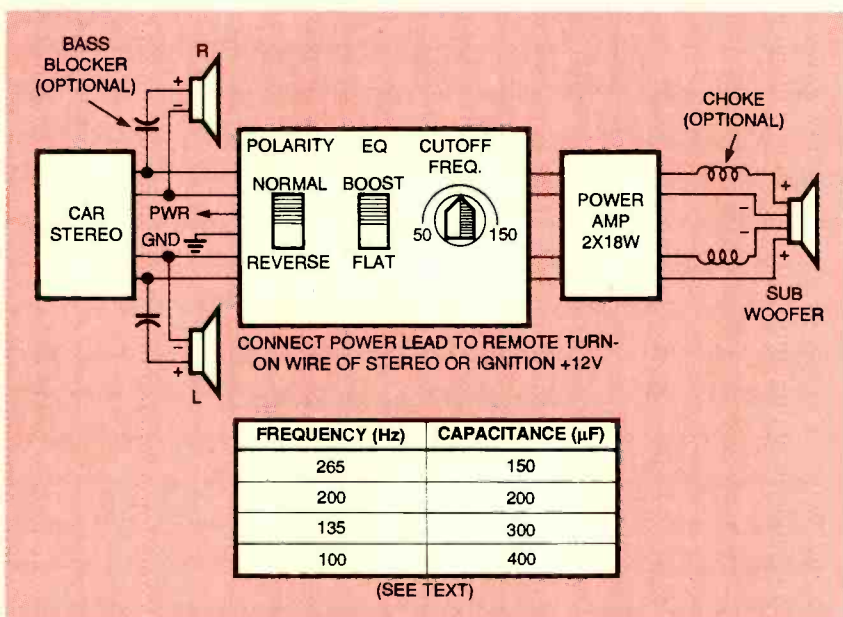


FIG. 7—CONNECTION DIAGRAM. Bass-blocking capacitors will reduce the burden of producing deep bass on the main speakers. The capacitor values for popular bass-blocking frequencies are listed below. The choke coils will prevent power amplifier oscillation problems.

power ratio. For systems with higher power separate components, a larger power amplifier and subwoofer should be considered to equal out the system.

### Speaker and enclosure

To get the best value here, build your own enclosure and use a dual-voice coil speaker. A dual-voice coil speaker can be connected directly to both out-

puts of a 2×18 amplifier, eliminating the need for two speakers. This essentially cuts the cost in half. A single 8- to 12-inch dual-voice-coil woofer is adequate for systems that will not have to entertain the whole neighborhood.

Choosing the right speaker is important. Polypropylene cone speakers are preferred because they are resistant to moisture.

The author used a Madisound No. 81524DVC speaker which has an 8-inch diameter polypropylene woofer and dual 4-ohm voice coils. It is available from Madisound for \$34.

Building your own cabinet not only saves a lot of money, it also lets you build cabinet with exactly the size and shape cabinet you want for your vehicle. This is important where space is tight or where an unusual interior would let you take advantage of some obscure location. Avoid installing the crossover and power amplifier where they are subject to excessive temperature (such as in direct sunlight) or where they are exposed to moisture or dirt. For a professional touch, speaker box carpet is available in colors to match almost any vehicle's interior, and it can be applied to the outside of the enclosure. If you prefer to use a premade speaker box, it can be purchased from Crutchfield, Parts Express, MCM Electronics, and other audio-supply distributors.

The prototype subwoofer is housed in a 1.25 cubic foot enclosure, which is the best trade-off between size and bass response. This box volume provides a cutoff frequency of 37 Hz.

The prototype's enclosure was constructed of 3/4-inch particle board, and a port was made from a 7½-inch length of 3-inch diameter PVC pipe. The computer-generated frequency response curve of the Madisound 81524DVC speaker in this enclosure is shown in Fig. 6.

### Installation

The subwoofer can be mounted inside the vehicle or in a trunk. If you install it in a trunk, use quick-connects for the wiring and adjustable straps or Velcro to keep the subwoofer from sliding around. This will also allow you to take the subwoofer out easily when you need the extra trunk room.

Connect the crossover inputs to the left and right speaker outputs of the car stereo, as shown in Fig. 7. If the stereo has front and rear outputs, use the out-

*Continued on page 94*

## BRIDGE CIRCUITS

continued from page 44

the resistance value of the bridge's potentiometer  $R_s$ .

### Inductance bridges

The two most popular bridges for measuring inductance are the *Maxwell bridge* (also known as the *Maxwell-Wien bridge*), shown in Fig 3 and the *Hay bridge* (also known as the

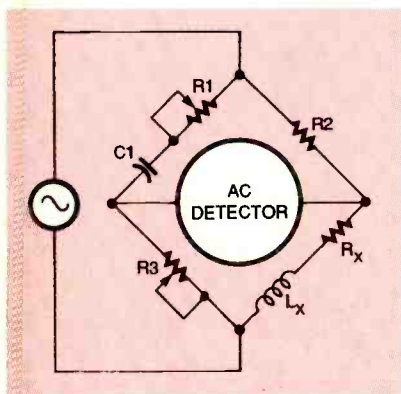


FIG. 4—THE HAY BRIDGE can measure the values of high-Q coils.

*opposite-angle bridge*), shown in Fig. 4. Both operate on the principle of balancing the inductive phase shift of the unknown inductor  $L_x$  against a capacitive shift of the same magnitude in the opposite arm of the bridge.

The Maxwell bridge, shown in Fig. 3, is widely used for accurate inductance measurements. It determines unknown inductance values with a standard capacitor, which has an advantage over a standard inductor because it is less likely to be influenced by external fields and is easier to shield. Moreover, the

field set up by a capacitor is negligible. Standard capacitors are small and inexpensive. The Maxwell bridge is useful for measuring coils with  $Q$  values below 10. The important Maxwell bridge formula's are:

$$L_x = R_2 \times R_3 \times C_1$$

$$R_x = (R_2 \times R_3) / R_1$$

$$Q_x = 2\pi f(L_x / R_x)$$

$$= 2\pi f C_1 \times R_1$$

Note: All  $Q$  values are influenced by the source frequency. Thus, a coil that has a  $Q$  of 100 with a high source frequency might have a  $Q$  of 1 or less at 1 kHz.

The *Hay bridge* is similar to the Maxwell bridge and is used for measuring inductances that have large values of  $Q$  (greater than 10) or whose resistance is a small fraction of the reactance  $X_L$ . The Hay bridge can also determine the incremental inductance of iron-cored reactors. The important formulas for the Hay bridge are:

$$Q_x = 1/2\pi f \times C_1 \times R_1$$

$$L_x = C_1 \times R_1 \times R_3 \times (1/1 + 1/Q^2)$$

$$R_x = 2\pi f \times L_x / Q$$

Figure 5 is the schematic for a combined Hay and Maxwell inductance bridge that spans the range of 10 microhenrys to 100 henrys in six ranges. The Hay circuit makes high- $Q$  measurements when switch S1-a and S1-b are set in the "H" position. When switch S1-a and S1-b is set in the "L" or Maxwell position, the bridge measures low values of  $Q$ .

In this circuit, AC voltages at both ends of the detector approach the half-supply value at balance. The AC detector here can also be a simple device such as headphones. Table 2 relates the selected switch channel to the inductance range, related

TABLE 3  
RESISTANCE VS. R, C, and L RANGE VALUES  
LABORATORY STANDARD BRIDGE

Switch S2 Range	Resistor R2 Value	Bridge Range Resistance	Capacitance	Inductance
1	10 $\Omega$	0 - 10 $\Omega$	0 - 10 $\mu\text{F}$	0 - 1 mH
2	100 $\Omega$	0 - 159 $\Omega$	0 - 1 $\mu\text{F}$	0 - 10 mH
3	1.0 K	0 - 1.59K	0 - 0.1 $\mu\text{F}$	0 - 100 mH
4	10 K	0 - 15.9 K	0 - 0.01 $\mu\text{F}$	0 - 1 H
5	100 K	0 - 159 K	0 - 1.0 $\mu\text{F}$	0 - 10 H
6	1 MEG	0 - 1.59 MEG	0 - 100 $\mu\text{F}$	0 - 100 H

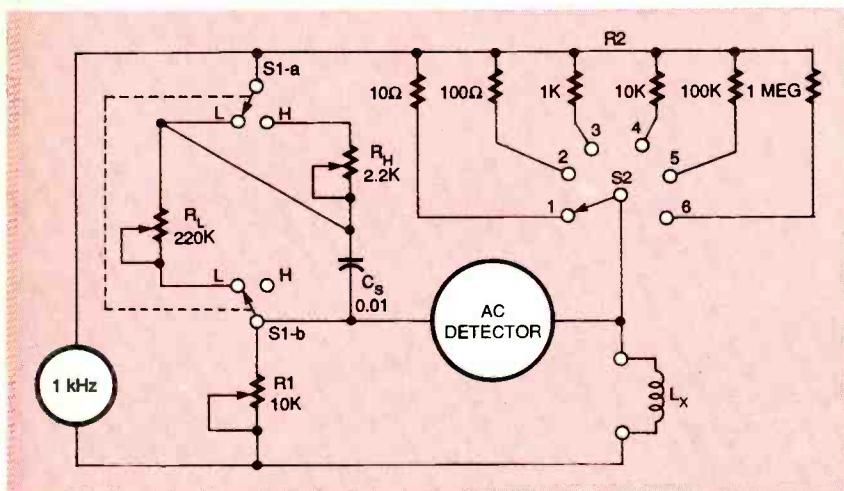


FIG. 5—THIS HAY-MAXWELL BRIDGE has six ranges.

TABLE 2  
RESISTANCE VS. INDUCTANCE RANGE VALUES  
HAY/MAXWELL INDUCTANCE BRIDGE

Switch S1 Range	Bridge Range	Resistor R2 Value	$Z_x$ Full Scale 1 kHz
1	0 - 1 mH	10 $\Omega$	15.9 $\Omega$
2	0 - 10 mH	100 $\Omega$	159 $\Omega$
3	0 - 100 mH	1.0 K	1.59 K
4	0 - 1 H	10 K	15.9 K
5	0 - 10 H	100 K	159 K
6	0 - 100 H	1 MEG	1.59 MEG

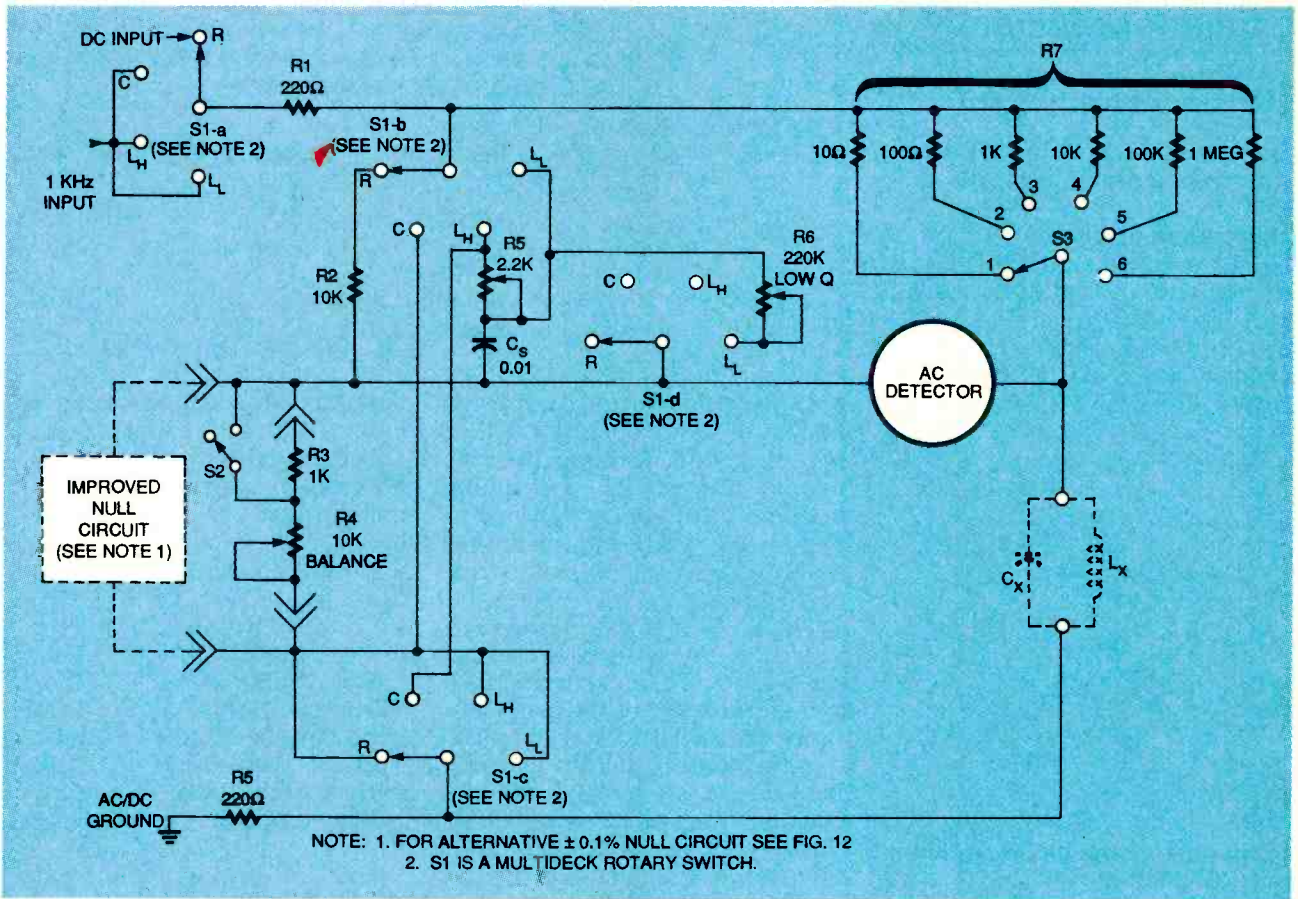


FIG. 6—THIS LABORATORY-STANDARD LCR BRIDGE has 18-ranges.

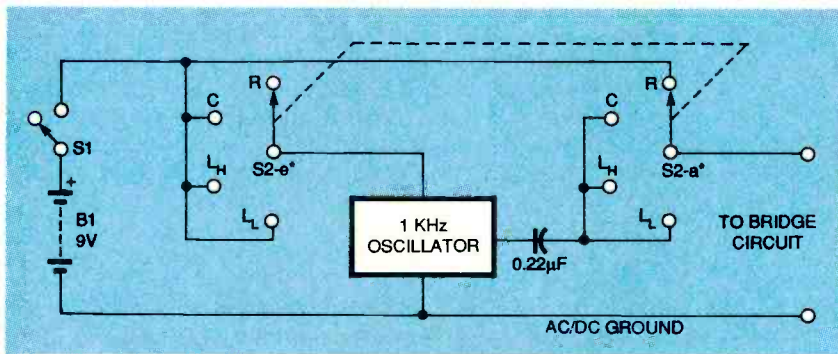


FIG. 7—AN AC/DC SOURCE for the 18-range laboratory-standard LCR bridge.

resistance value, and full-scale impedance.

### Precision LCR bridge

Figure 6 is the schematic for a precision 18-range LCR bridge that combines the circuits of Figs. 5 and 2 with a Wheatstone bridge. Although this bridge is very sensitive, it requires only a simple AC balance detector. This could be an analog voltmeter on its DC-sourced resistance ranges, or a headphone on its the AC-sourced capacitance and inductance

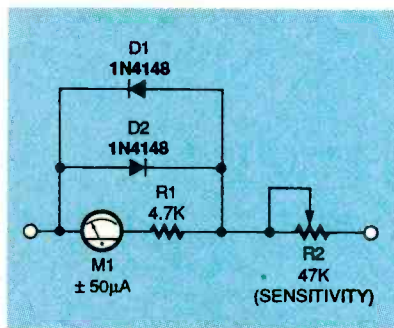


FIG. 8—A DC-NULL DETECTION circuit.

ranges. A simple radio receiver will also work when the ear is

not sensitive enough to discriminate against harmonics.

The null-balance network of this circuit has been modified by the addition of a 1-kilohm resistor R3 and switch S2, which permit the span of each range to be extended by 10%.

When this bridge is set on its 0 to 100-picofarad range, errors can occur because of the effects of stray capacitance. Consequently, measurements should be made with the *incremental* method, as follows:

1.—With no component across the unknown terminals, null the bridge with potentiometer R4 and record the resulting *residual* null reading (typically about 15 pF).

2.—Insert the unknown capacitor in place, obtain a balance reading (e.g., 83 pF), and then subtract the residual value (e.g., 15 pF) to obtain the true capacitor value (in this example, 68 pF).

Table 3 relates the switch range to the resistor value in the channel selected and the vari-



continued from page 62

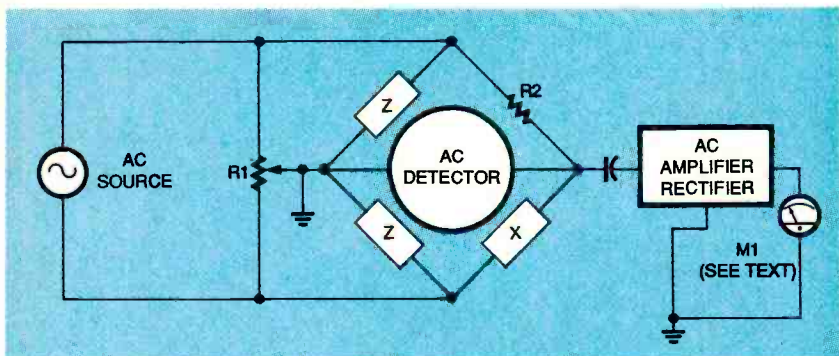


FIG. 9—A WAGNER EARTH CONNECTION in a single-ended AC null detector.

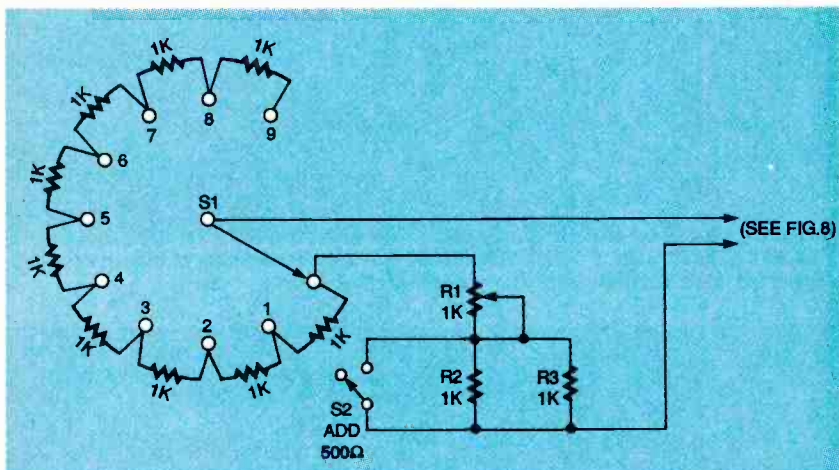


FIG. 10—CIRCUIT FOR IMPROVING null resolution of the LCR bridge to  $\pm 0.1\%$  of full scale.

ous ranges of resistance, capacitance, and inductance.

The bridge circuit in Fig. 6 can be built as shown for use with external AC and DC sources and null-detection circuitry, or can be modified to suit your specific requirements. Fig. 7 shows an AC/DC source that can be added if a five-wafer multideck rotary switch is installed in Fig. 6 and the "e" wafer is left blank.

Both DC and AC null-balance detectors can easily be included in the Fig. 6 circuit. The DC detector can be a microammeter capable of measuring  $\pm 50$  microamperes. Figure 8 is the schematic for a microammeter protection circuit consisting of two back-to-back 1N4148 silicon diodes and R2, a 47-kilohm potentiometer for adjusting sensitivity.

Figure 9 shows a simplified schematic for an AC detector. It includes a single-ended AC analog millivoltmeter. The low input of the detector and the detector junction on the left side

of the bridge can both be grounded. This diagram also shows how the AC source can be equipped with a *Wagner earth connection*, supplied by potentiometer R1. This potentiometer permits the source signal to be balanced to ground to eliminate unwanted signal interference at null.

Figure 10 is the schematic for a null resolution circuit that can be installed in the LCR bridge, shown in Fig. 6. The bridge has a resolution that is only about  $\pm 1\%$  of full scale. This is set by the limit of readability of the R3 and R4 balance control's scale.

The circuit in Fig. 10 will improve the bridge's resolution by a factor of 10 to  $\pm 0.1\%$  of full-scale. Remove Switch S2, resistor R3 and potentiometer R4 and install the switched and variable network of Fig. 10 at the male and female connectors shown on Fig. 6. Switch S2 permits the 1-kilohm linear potentiometer R1 to go overrange by 50%.  $\Omega$

large corporations. On the other hand, some people think that Notes is nothing but glorified E-mail.

Even the U.S. Department of Justice, which has been very active of late in overseeing mergers and acquisitions in the computer industry, has shown no interest in the deal.

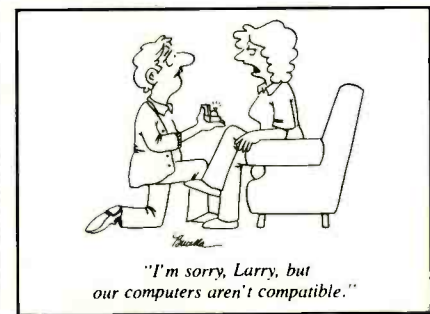
My question is this: What about this deal would appeal to the average Microsoft customer? The computer market *is* Microsoft customers.

If two 500-pound gorillas join forces, it's still a family of gorillas. Meanwhile, the smaller, faster, and smarter chimpanzees maintain advantages for both survival and evolution.

**Novell buys Borland**

Which reminds me: Novell, which last year bought WordPerfect, is now trying to buy Borland. Borland does have some good products, and a loyal following of influential buyers. But what can Novell and Borland do together that they couldn't do separately?

If Novell uses Borland's tools to expand the development platform for NetWare and UnixWare *without impeding progress in the PC tools market* the company may generate additional interest in those areas. What that means is perhaps five years of market and product development before NetWare's market is completely overshadowed by some form of Windows. But if Novell meddles deeply with team Borland, I predict personal delivery of champagne and caviar by none other than Bill Gates. As a reminder, you can contact me on CompuServe as 72170, 2226, or via the Internet at 72170.2226@Compu-Serve.Com. **EN**



## SEEING THE UNSEEN

*continued from page 46*

Thus, a succession of closely timed images following one another at brief intervals is interpreted by the brain as a seamless sequence. That is why the moving machine appears to be standing still.

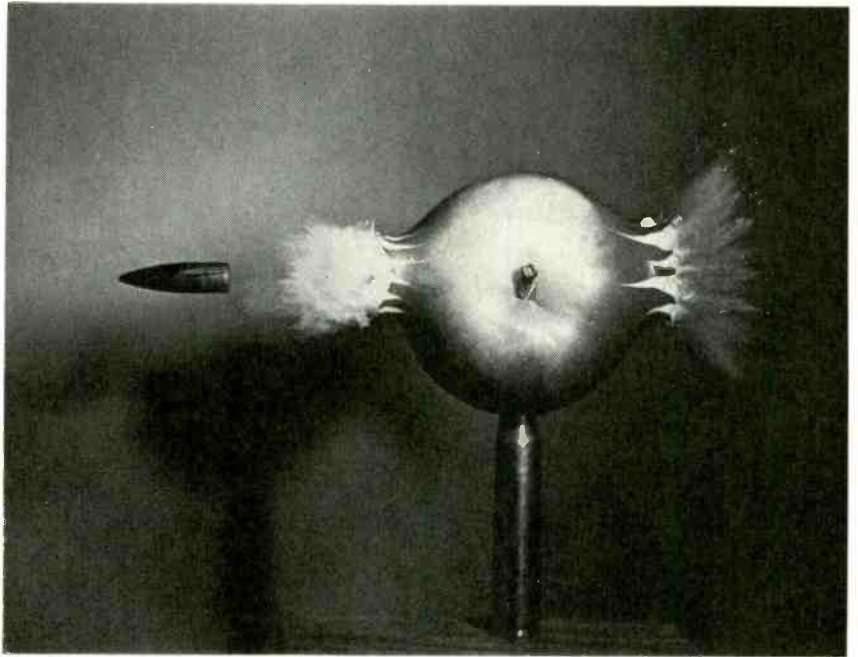
Persistence of vision is the same response that makes it possible to view movies, television, and raster-scanned computer monitors. (See "Scanning Early TV," *Electronics Now*, July 1995, page 46.) Crude stroboscopes had been available as laboratory instruments as early as 1918, but they had not been used as industrial research tools.

### Stroboscope history

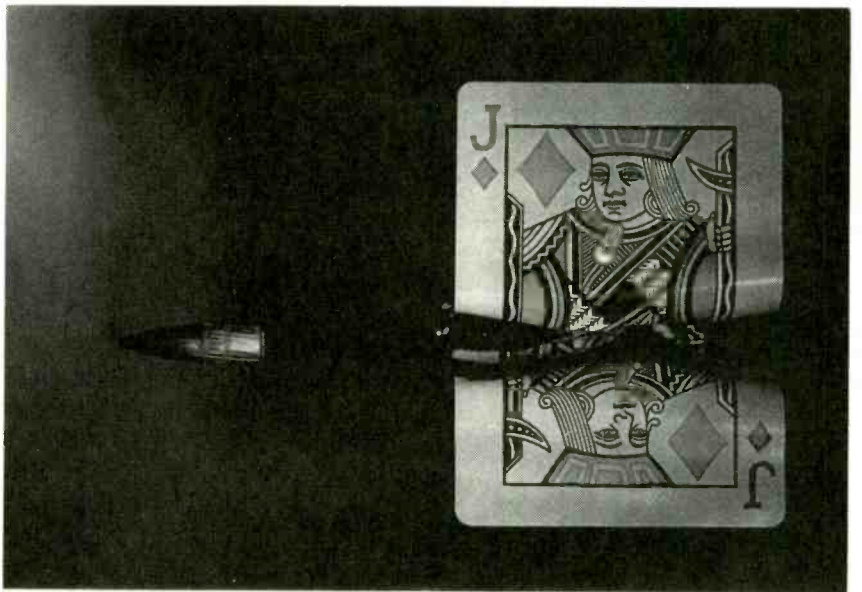
Although the name Edgerton is virtually synonymous with the stroboscope, he did not invent the device. His association with the subject hinged on his ability to find practical applications for the instrument rather than for its invention. That honor goes to Dr. Peter Roget (1779-1869), who invented a mechanical form of stroboscope while studying the effects of persistence of vision.

In later developments, the Belgian scientist, Joseph Plateau (1801-1833), built a rotating device he called the *Phenakistoscope* in 1829 that created the illusion of continuous motion. His work was based on his own observations and Roget's earlier research. At about the same time, a Viennese scientist, Simon von Stampher (1792-1864), invented a similar mechanical device that he called a *stroboscope*, a name from the Greek meaning "to view a whirling disk." Both devices were essentially whirling slotted wheels bearing little resemblance to the modern electronic strobe.

After recognizing the value of the stroboscope for analyzing faults in moving machines, Edgerton built his own bench-type electronic model. Then, after modifying his invention to make it easier to manufacture,



THIS .30 CALIBER BULLET, traveling at 2800 feet per second, was photographed with a one-third microsecond flash. The apple then flew apart.



CUTTING THE CARD BY bullet.

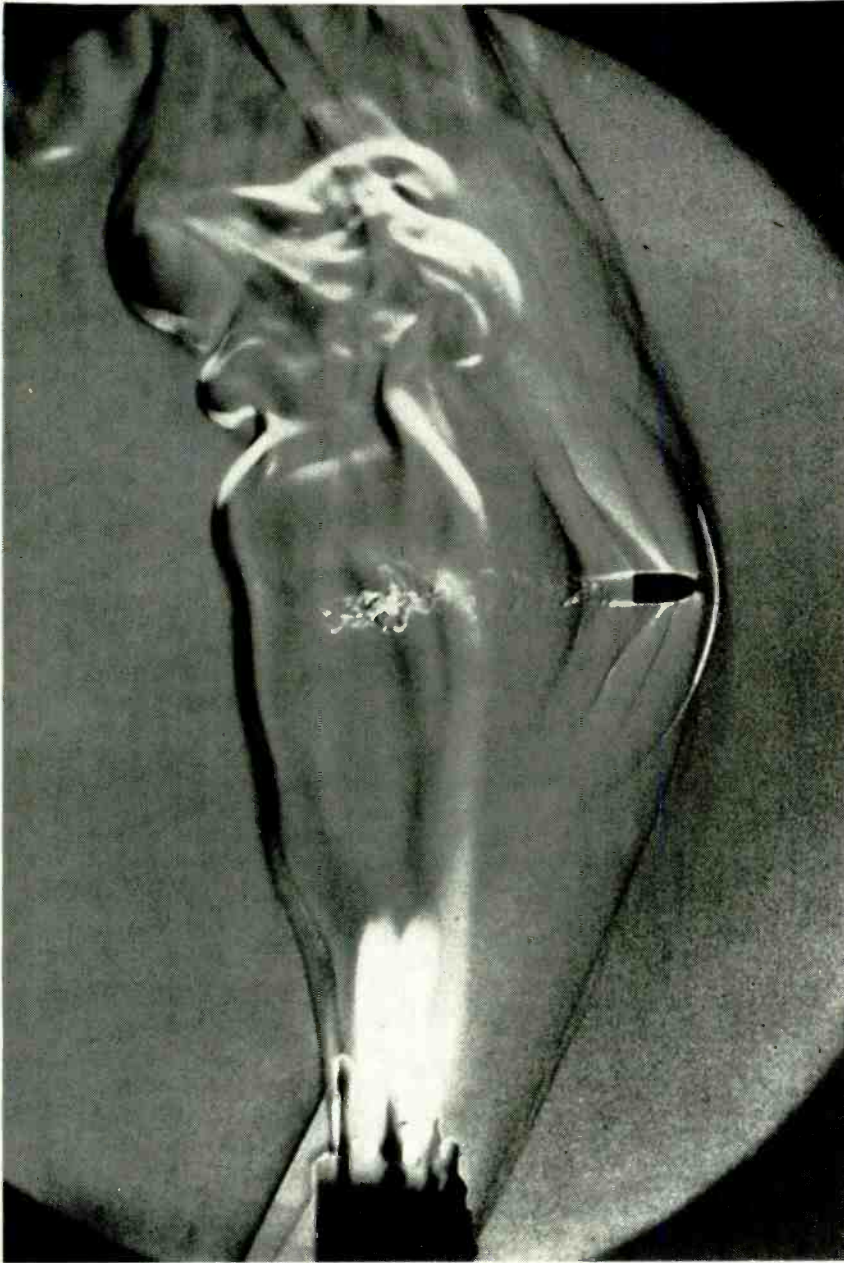
he arranged to have General Radio Corp., Cambridge, Mass. (now GenRad, Inc.), manufacture and sell them. These instruments later evolved into standard test instruments that were widely used.

### Stop-action photography

In 1833, five years before the invention of photography, the English physicist Sir Charles Wheatstone (1802-1875), best known for his association with the bridge circuit of the same name and early forms of tele-

graph, suggested that short-duration light pulses from electric arcs would make fast-moving objects appear to stand still. He turned out to be right.

An early pioneer in photography, W.H. Fox Talbot (1800 to 1877), was the first person to demonstrate Wheatstone's theory. This Englishman had previously developed an independent photographic process that could print many positives from a single paper negative coated with silver iodide. Talbot made the world's first high-speed pho-



**SUPERSONIC CANDLELIGHT.** A photo showing a .22 caliber bullet passing through a candle flame.

tograph in 1851 when he put a copy of a newspaper on a whirling disk in a dark room and discharged a bank of Leyden jars (crude capacitors made as metal covered jars) to obtain a spark from an electrostatic discharge. The spark was bright enough to "freeze" the image of the whirling newspaper on the very slow photographic emulsions then available. The text from the newspaper captured in the photograph was readable.

The English scientist, Michael Faraday (1791-1867), also became interested in per-

sistence of vision and stroboscopy. He is best known for his pioneering work in electromagnetic induction and as the discoverer of the basic principles of the electric motor. After observing that a moving toothed gear in a mill, when viewed through an adjacent moving toothed gear, appeared to be standing still, he built a small gear system in his laboratory (called Faraday's Wheel) to duplicate the phenomena. Although he made no real contribution to the subject, he provided Talbot with the battery

and Leyden jars that were needed for his work.

High-speed photography was advanced by the invention of a gas-filled, light-emitting tube that could provide a controlled, continuous source of bright light. Its inventor, the German physicist, Heinrich Geissler (1814-1891), was seeking a continuous light source for spectroscopy. Later it was found that the Geissler tube could be pulsed.

An Austrian inventor, Ottomar Anschutz (1846-1907), devised the first practical high-speed mechanical camera shutter while attempting to animate high-speed photographs that he had sequentially photographed. His *Electrotachyscope* consisted of a large rotating disk and a Geissler tube, which he pulsed with a mechanical contactor. This apparatus made possible the generation of suitably bright, short-duration light pulses.

Other important early contributors to the wonders of strobe and stop-action photography included the English photographer, E. Muybridge (1830 to 1904), and the French physiologist Etienne Jules Marey (1830 to 1904).

Muybridge settled the ancient question about whether all four legs of a galloping horse ever leave the ground simultaneously. He set up a series of cameras a foot apart whose shutters were triggered by strings.

This setup provided a uniformly spaced series of photographs of a horse galloping along a track in front of the cameras. The pictures showed that there were brief periods when all four legs were off the ground.

Marey introduced the principle of intermittent motion in 1882. He set up cameras that were able to make 12 exposures a second on a rotating glass plate with each exposure made at 1/720 second. His pictures of a jumper, for example, showed, on a single photographic plate, discrete changes of position as the athlete started and completed the jump. This work led,

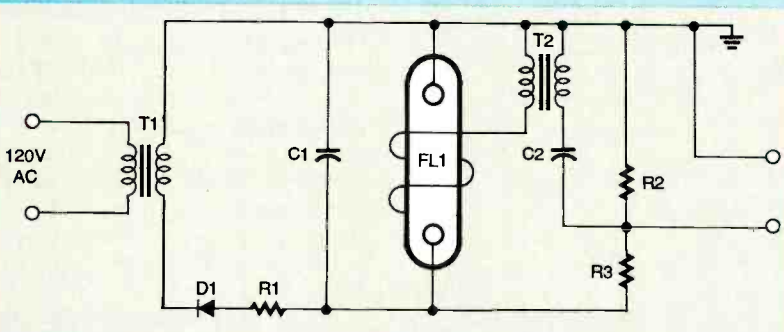
## FLASHTUBE TECHNIQUES

The figure shows an elementary circuit for triggering xenon-filled flash tubes with one external and two internal electrodes. The tube is connected across the main flash capacitor C1, which stores the energy that the lamp converts to light. Rectified current from transformer T1 charges capacitor C1 to a voltage equal to the peak voltage of transformer T1's secondary winding.

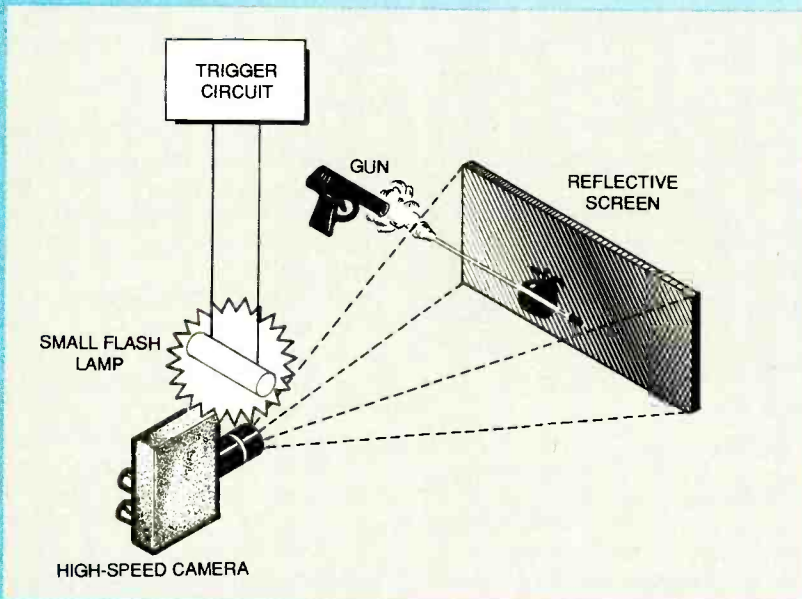
When switch S1 is closed, an electrical discharge begins in the flashtube. (S1 can be a contact in a synchronized camera shutter.) The pulse voltage in the secondary of the step-up transformer T2 is fed to the external electrode of the lamp to induce current in it by

capacitive discharge. Once the glow on the tube walls begins, the lamp is lighted briefly but brilliantly by the capacitive discharge.

Multiflash, a term coined by Edgerton, is an electronic flash system (either single or multiple units) that can be fired manually or automatically in sequence. The interval between successive flashes and photographed images is determined by the activity being photographed. For example, when a golfer is photographed driving a ball, the flash might be fired automatically 100 or more times per second. A diver diving from a platform might be photographed only five or six times.  $\Omega$



**METHOD FOR TAKING pictures of a high-frequency bullet in flight against a reflective screen.**



**TRIGGER CIRCUIT FOR FIRING an electronic flashtube.**

graduates had difficulty finding work in their chosen fields. Many of these people preferred to work at little or no pay rather than change fields to earn more money.

Two of Dr. Edgerton's graduate students, Kenneth Germeshausen and Herbert Grier, had completed their studies but were unable to get jobs. Edgerton was, however, able to persuade MIT to keep them on as unpaid research assistants in the Dynamo Lab.

This situation motivated Edgerton to think of ways that they could pool their knowledge and earn money as consultants to industry. He also wanted to supplement his own meager instructor's salary.

In 1931, Edgerton and Germeshausen formed a partnership to study high-speed photographic and stroboscopic techniques and their applications. Grier joined them in 1934. Edgerton, Germeshausen and Grier, Inc. was actually founded in 1947. (It later changed its name to EG&G.) However, during World War II, the Government's Manhattan Project made use of Edgerton's inventions while the three engineers were still working only as partners.

### Strobes and photos

While pursuing his outside consulting activities and teaching at MIT, Dr. Edgerton was moving up the academic ladder. Something of Edgerton's personality emerges in this period of his life—his acceptance of the nickname "Doc" given to him by a colleague. It really emphasized his unique problem-solving abilities and his reputation as a mentor to graduate students rather than his possession of a doctor's degree. The MIT campus abounded with them at the time. "Doc" stuck for the rest of his life. He became a full professor of electrical engineering at MIT in 1948.

In the 1930s, Doc Edgerton's research was focused on stroboscopes for direct visual examination of moving machines. When stroboscopes were coupled to high-speed

more than 50 years later, to Edgerton's development of multiflash images.

### Founding a consulting firm

In the years after Dr. Edgerton received his doctorate degree

and became an instructor at MIT, the United States had entered a long period of economic depression. In the early 1930s, the salaries of instructors and professors were extremely low, and even the brightest college

movie cameras, the stopped action could be recorded.

After investigating alternative light sources, he found that flashtubes were the only practical sources of the high-luminance, very short flashes of light suitable for ultra-high-speed photography. The light from magnesium flares could not be controlled, and the light from flashbulbs, although controllable with electronics, persisted too long.

The early experimenters in high-speed photography had used a spark gap, but it was satisfactory only where a small-volume source of very short duration is required. By contrast, the xenon-filled flashtube has an efficiency five times greater than the open spark.

The flashtube consists of a glass or quartz tube filled with gas and contains two or more electrodes. Other gases such as argon, neon, and krypton will work in flashtubes, but xenon provides the whitest light. These tubes can produce light pulses of one microsecond duration or less, and they can be fired thousands of times without needing replacement.

Because no satisfactory commercial flashtubes and trigger circuits were available commercially at the time, Edgerton invented his own. He developed a xenon-filled flashtube and trigger circuits that could produce the required high-intensity bursts of light.

Edgerton had a number of models built, and he sold them to professional photographers. This system later became a successful commercial product, and it remains the basic flash apparatus for still photography. The xenon flashtube also became an ideal stroboscope, and later xenon flashtubes would serve as optical pumps for pulsed lasers.

With his flash equipment Edgerton was able to make the photographs reproduced here. The bullets were traveling at speeds in excess of 2000 feet per second. The pictures, which possess artistic beauty, were of great interest and value to science and industry.

### **Aerial and undersea photos**

In 1936, well before oceanography became a recognized scientific discipline, Dr. Edgerton developed his first underwater camera and lighting system suitable for use at extreme depths of a mile or more. He used a 16-inch naval shell as the container for both camera and strobe because it was strong enough to withstand the tremendous pressures at those depths. The naval shell was also large enough to house the bulky photographic equipment.

After the publication of his book *Flash: Seeing the Unseen by Ultra-High-Speed Photography*, the U.S. Army Air Force became interested in the use of strobe lamps for night aerial photography. After the United States entered World War II, strobe lamps became so important to the war effort that Edgerton was sent to England in 1944 to supervise the outfitting of aircraft with those lamps for night photography.

This equipment was used to photograph the Normandy beaches before the D-day invasion to confirm that there were no concentrations of German military equipment in the vicinity. Later Dr. Edgerton went to both France and Italy to advise the U.S. Army Air Force on night aerial photography. He was awarded the Medal of Freedom for his efforts.

Edgerton's services to the U.S. Government continued well into the post war period. During World War II, the government had used Edgerton's equipment to photograph atomic bomb explosions. After the war and the founding of Edgerton, Germeshausen and Grier, Inc., it was a natural transition for the company to support the Atomic Energy Commission (AEC) in its weapons research and development. The company was awarded contracts for managing atomic bomb testing. Edgerton-designed cameras photographed hydrogen bomb tests that were conducted both in Nevada and on Pacific Islands. These photos were vital in analyzing bomb performance.

After the war Edgerton also returned to underwater research and photography. He met with Jacques Yves Cousteau, the famed French undersea explorer and inventor of the aqualung, and began a decades-long collaboration in which Edgerton designed custom cameras for Cousteau, sometimes diving with him from Cousteau's research vessel *Calypso* to operate the equipment. The equipment was made by Edgerton, Germeshausen and Grier.

In 1953 Edgerton developed the "pinger," a high-frequency sonar projector that could determine precise locations on the ocean floor. In the process he discovered that the lower sonar frequencies partially penetrated the soft sediments on the ocean floor to reveal underlying rocks. Sonar beams from his low-frequency "boomer" located buried rocks off the coast of Puerto Rico that are believed to have been heaved up from the deepest layers of the Earth's crust.

Later, Edgerton designed the side-looking sonar that located the Union ironclad battleship *U.S.S. Monitor* (the cheesebox on a raft) which had sunk off the coast of North Carolina in a storm. This was the ironclad that had previously fought the Confederate ironclad *C.S.S. Merrimac* in the first battle between ironclads, March 9, 1862, off the Virginia coast. Edgerton was intrigued by the search for the Loch Ness monster in Scotland, so he had special sonar scanners and underwater cameras built in an attempt to track down the legendary sea serpent.

EG&G, Inc. now makes instruments and optoelectronic and mechanical components. Its products include devices that emit and detect light across the complete spectrum from ultraviolet to the far infrared. Although it still offers technical services to industry and government, it announced last year that it was ending its management and operating functions for the U.S. Department of Energy (DOE), successor to the AEC.

## SUBWOOFER

continued from page 86

puts that will be turned up for the loudest sound. Because the subwoofer crossover has a high input impedance, it does not load the receiver, and full power is still provided to the main speakers. The subwoofer crossover sums the signals from the left and right channels, so the left and right inputs are interchangeable.

Since the inputs of the subwoofer crossover are isolated from ground, the positive and negative inputs are also interchangeable. Be sure to observe the same polarity for both the left and right channels. This interchangeability feature is particularly useful when speaker polarity is unclear. The crossover's phase switch can reverse the input polarity to provide the correct phase.

Use a short cable to connect the subwoofer crossover to the power amplifier to prevent ignition noise pickup.

Adding bass-blocking capacitors in line with each of the main speakers is recommended, as shown in Fig. 7. This reduces the burden of reproducing deep bass on the main speakers, allowing higher

volume with less distortion.

The capacitor values to use with 4-ohm speakers for popular bass-blocking frequencies are listed in Fig. 7. Bass-blocking capacitors should be non-polarized (bipolar). Use 135-Hz bass-blockers for most applications. Choose a higher frequency when the main speakers are weak in bass response.

Adding a choke coil in series with each side of the dual-voice-coil subwoofer (see Fig. 7) will prevent power amplifier oscillation problems. The inter-winding capacitance or mutual inductance of dual-voice-coil subwoofers can cause some power amplifiers to oscillate. You can purchase choke coils inexpensively, or wind your own. Twenty turns of No. 22 wire wrapped around a 1/4-inch diameter steel bolt will provide an approximate value of inductance of about 20 microhenries.

Power for the subwoofer crossover and power amplifier can be supplied from the automobile's +12-volt ignition lead or from the remote turn on/power antenna lead.

### First power up

Before turning the system on for the first time, set the volume controls of the subwoofer amplifier and the receiver to minimum. Set the crossover cutoff frequency control to maximum (fully clockwise).

After turn on, increase the receiver volume slightly to verify that sound is coming from each of the main speakers. If it does not, check for short circuits or open connections.

If sound comes from each of the main speakers, increase the subwoofer power amplifier level. Listen for bass from the subwoofer. If little or no sound is heard, try setting the receiver's balance control all the way to one limit. If this produces bass, one of the crossover inputs is connected backwards.

The most important step in adjusting a subwoofer system is to set (and keep) the stereo's bass control at or below the flat (middle) position. Vehicle interior acoustics are notorious for overemphasizing upper bass

frequencies. By turning the bass control down, boomy-sounding upper bass is reduced. By adjusting the subwoofer crossover cutoff frequency for optimum sound, the subwoofer will fill in a deep, solid sounding bottom end.

Set the crossover polarity switch (S1) to position which gives the most bass. Set the crossover Eq. switch (S2) in the "boost" position to increase deep bass frequencies and to help extend the subwoofer's response. Use the "flat" position if you hear distortion from the subwoofer. Adjust the crossover cutoff frequency and the level control of the amplifier to provide the best sounding bass.  $\Omega$

### NEW Product Announcement

Universal Cable TV Descrambler

No Converter Necessary

Works With All Systems

Call 1-800-664-6999



**Quality Microwave TV Systems**  
WIRELESS CABLE • ITFS • MMDS  
ATV • INTERNATIONAL • S-BAND  
Amplifiers • Antennas • Books • Components  
Filters • Systems • Video Products  
• RF Frequency 1990 - 2700 MHz  
• Cable Ready - VHF - UHF Outputs  
• SASE For "FREE" Catalog or Send \$1  
**PHILLIPS-TECH ELECTRONICS**  
PO Box 8533 • Scottsdale, AZ 85252  
ORDER LINE 800-880-MMDS  
CATALOG/INFO 602-947-7700  
FAX LINE 602-947-7799  
CHALLENGER SYSTEM  
33-Channel 52dB Gain  
Complete Grid \$265  
Five Year Warranty  
FREE SHIPPING Visa • MC • Amx • Disc • COD's • Qty Pricing

**CABLE TV  
DESCRAMBLERS**  
**1-800-233-9388**  
**FREE CATALOG**  
GUARANTEED BEST PRICES • IMMEDIATE SHIPPING  
**APPLE ELECTRONICS**  
3388 Sheridan St. • Suite 257  
Hollywood, FL 33021

AMERICAN HEART  
ASSOCIATION  
MEMORIALS & TRIBUTES



1-800-AHA-USA1  
American Heart Association

### SOURCES

#### Crutchfield

1 Crutchfield Park  
Charlottesville, VA 22906  
(800) 955-3000  
(car stereo components)

#### Madisound Speaker Components

8608 University Green  
P.O. Box 44283  
Madison, WI 53744-4283  
(608) 831-3433  
(speaker building supplies)

#### MCM Electronics

650 Congress Park Drive  
Dayton, OH 45459-9955  
(800) 543-4330  
(speakers, boxes, car stereo, electronic components)

#### Parts Express

340 East First Street  
Dayton, OH 45402-1257  
(800) 338-0531  
(speakers, boxes, car stereo, electronic components)

# BUYER'S MART

## PLANS AND KITS

**60 SOLDERLESS Breadboard Projects** in two easy-to-read pocket books. Complete with circuit descriptions, schematics, parts layouts, component listings, etc. Both book (BP107 & BP113) only \$11.90 plus \$4.00 for shipping. USA and Canada only. US funds. **ETT, INC.**, PO Box 240, Massapequa Park, NY 11762-0240.

**CRYSTAL set Handbook** — Visit antiquity by building the radios your grandfather built. Assemble a "Quaker Oats" rig, wind coils that work and make it look like the 1920s! Only \$10.95 plus \$4.00 for shipping and handling. **CLAGGK INC.**, PO Box 4099, Farmingdale, NY 11735. US funds only! USA and Canada — no foreign orders.

**SURVEILLANCE/Countersurveillance**, bugging/phone tapping detector, telephone/fax encryption, vehicle tracking, covert video, transmitters kit, and more... **A.B. ELECTRONICS**, 1 (800) U-ANTI-BUG.

**FIBER Optics experimenters parts, supplies and tools:** Fiber, cable, connectors, splices, detectors, lasers, kits, plans, newsletter. Send \$2.00 for catalog. **LIGHTLINE ENGINEERING**, PO Box 24, Mullica Hill, NJ 08062.

**ALL-IN-ONE CATALOG. AM/FM/HAM/SPY.** Transmitters, amplifiers, receivers. Voice scramblers/disguisers. Audio, TV, Tesla coils, plans, "Secret" books, kits, imports, exports and more. Start your own licensed or unlicensed radio station. 60 full pages for \$1.00. **PAN-COM INTERNATIONAL**, PO Box 130-F10, Paradise, CA 95967.

**ALL schematics.** TV's, VCR's, camcorders, audio, fax, monitors, computers, printers, originals, up to date, hard to find, from AIWA, Zenith, \$5.00 and up. (305) 434-9780.

## BUSINESS OPPORTUNITIES

Start your own technical venture! Don Lancaster's newly updated **Incredible Secret Money Machine II** tells how. We now have autographed copies of the Guru's underground classic for \$18.50. **SYNERGETICS PRESS**, Box 809-C, Thatcher, AZ 85552. (520) 428-4073. Visa/MC.

I have the idea. You have the microelectronic manufacturing skill. You make it. I sell it. **REEMIND**, 4218 Bunkerhill, Bettendorf, IA 52722.

## EDUCATION & INSTRUCTION

**ELECTRONIC engineering.** 8 volumes complete. \$109.95. No prior knowledge required. Free brochure. **BANNER TECHNICAL BOOKS**, 1203 Grant Avenue, Rockford, IL 61103.

**LEARN VCR repair.** Great profits. Home study. P.C.D.I., Atlanta, GA. Free literature. 1 (800) 362-7070 Dept. VRL342.

**LEARN PC repair-troubleshooting, servicing.** Home study. Free literature. P.C.D.I., Atlanta, GA 1 (800) 362-7070 Dept. JLL342.

**PAY TV AND SATELLITE DESCRAMBLING**  
all new info      Volume 6      all new info

Volume 6: Our entire collection of all current cable satellite and wireless turn-ons Pay TV volumes 1-5 (all different Vol. 1 basics) Satellite and DBS Handbook (includes Hacker info) Wireless Cable Hacking Hacker Video Complete Wizard (VCI+) Cellular Phone Hacking \$15.95 each or 3/34.95 or 5/52.95 Newsletter \$29.95/12 issues. Catalog \$1. All our info \$129.95 (includes sub)

Scrambling News  
3494 Delaware Ave. Buffalo, NY 14217-1230  
PHONE: FAX: 716-874-7000 800-728-8111-1003

**CABLE - TV NOTCH FILTERS**

- FOR ELIMINATING RF INTERFERENCE
- FOR BLOCKING UNWANTED CHANNELS



□ AVAILABLE FOR VHF CHANNELS  
  □ THRU 36 AND 95 THRU 99

□ PRICING AS LOW AS \$12 EACH

Call or write for a  
**FREE brochure today!**

**STAR CIRCUITS**  
PO. BOX 94917  
LAS VEGAS, NV 89193  
**1-800-535-STAR**

**MICROWAVE oven manual**, to become a technician. Award winner edition. USA \$42.95, all foreign countries \$69.00. **RANDALL**, Box 2168 R, Van Nuys, CA 91404.

**TODAY'S Electronics.** Don't get left behind! Top home-study courses developed by U.S. Military. Free Catalog. **FEDERAL TECHNICAL PUBLISHERS**, Box 1218, E. Glen Lake, MN 55345.

## CABLE TV TURN-ON CHIPS

**SUPER Cable TV "Test Chips"**. Provides full service activation. Excellent instructions & illustrations. **Jerrold Starcom**: DP(V)5, DP(V)7, DPBB7, CFT-2000 series. **Pioneer**: BA-5000 thru BA-6700. **Scientific Atlanta**: 8500 thru 8600. **Tocom**: 5503-VIP-5507. **Zenith**: ST-1000 thru ST-5000. Call now!! **MAS-TER COMPONENTS**. 1 (800) 233-0570.

## INVENTIONS

**FREE invention package: DAIVSON AND ASSOCIATES** offers customized development, patenting, and licensing of new products and ideas. Proven results: 1 (800) 677-6382.

## CABLE TV DESCRAMBLERS

- Quantity Discounts • 24 Hour Shipping
- Save Money Don't Rent

**NOBODY BEATS OUR PRICE**  
Call Us Last For Best Price  
**1-800-677-0321**  
Anyone implying theft of service will be denied service  
VCI - NO FLORIDA SALES

**SURVEILLANCE**  
A COUNTERSURVEILLANCE Electronic Devices

Cover Video Cameras • Transmitter Kits • Voice Changers  
Bug and Phone Tap Detectors • Shotgun Mics • Micro Recorders  
• Vehicle Tracking • Locksmithing • AND MORE!

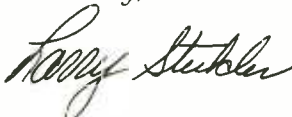
16 - Hour Telephone Recorder - silently tapes incoming/outgoing phone calls automatically. **\$199.00**

**SPY** FOR CATALOG SEND \$5.00 TO... **FREE! GAIN! WELCOME!**  
**OUTLET** P.O. Box 337, Buffalo, NY 14226 (716) 691-3476

Dear Classified Advertiser:

Effective with the January 1996, issue the Buyer's Mart will be merged with the Electronic Shopper Classified. To order new advertising use the form in the Shopper Classified section. For information contact our New York Advertising Department.

Sincerely,



Larry Steckler, EHF, CET  
Publisher, Editor-in-Chief

LS/ce

## FOR SALE

**TUBES:** "oldest", "latest". Parts and schematics. SASE for lists. **STEINMETZ**, 7519 Maplewood Ave. RE, Hammond, IN 46324.

**TUBES**, new, up to 90% off, SASE, **KIRBY**, 298 West Carmel Drive, Carmel, IN 46032.

**CABLE test chips.** Jerrold, Tocom, S.A., Zenith. Puts cable boxes into full service mode! \$29.95 to \$59.95. 1 (800) 452-7090. (310) 902-0841.

**SECRET cable descramblers!** Build your own descrambler for less than \$12.00 in seven easy steps! Radio Shack parts list and free descrambling methods that cost nothing to try, included. Send \$10.00 to: **INFORMATION FACTORY**, PO Box 669, Seabrook, TX 77586. For Visa/MC, COD's (713) 922-3512 any time.

**300 Experimenters Circuits** — Complete in 6 practical books using diodes, relays, FET's, LEDs, IC 555's, and IC CA3130's for building blocks. Only \$33.00 plus \$6.00 for shipping. USA and Canada only. US funds. **ETT, INC.**, PO Box 240, Massapequa Park, NY 11762-0240.

**RESTRICTED information:** Surveillance, Locksmithing, Cable, Hacking, Investigation, transmitter kit, Etc. **MENTOR**, Box 1549-Z, Asbury, NJ 07712.

**ANTIQUE RADIO CLASSIFIED**  
**Free Sample!**



Antique Radio's  
Largest Circulation Monthly.  
Articles, Ads & Classifieds.

6-Month Trial: \$17.95. 1-Yr: \$34.95 (\$51.95-1st Class).  
A.R.C., P.O. Box 802-L15, Carlisle, MA 01741  
Phone: (508) 371-0512 VISA/MC Fax: (508) 371-7129

**CABLE TV converters and accessories.** Fair prices, quality service, and 14 years experience gives us the advantage. Call 1 (800) 952-3916 V/MC/Amex/Disc/COD. **ADVANTAGE ELECTRONICS, INC.**, 1125 Riverwood Dr., Burnsville, MN 55337. Member of NCCA.

**THE Case Against the Patents.** Thoroughly tested and proven alternatives that work in the real world. \$28.50. **SYNERGETICS PRESS**, Box 809-C, Thatcher, AZ 85552. (520) 428-4073. Visa/MC.

**CABLE descrambling.** New secret manual. Build your own descramblers for cable and subscription TV. Instructions, schematics for SSAVI, gated sync, sinewave, (HBO, Cinemax, Showtime, UHF, Adult) \$12.95, \$2.00 postage. **CABLETRONICS**, Box 30502R, Bethesda, MD 20824.

**CABLE TV EQUIPMENT & ACCESSORIES.** Wholesalers welcome! 30 day moneyback guarantee! Free catalog! **PERFORMANCE ELECTRONICS, INC.**, 1 (800) 815-1512.

**TV Notch filters**, free brochure. **MICRO THINC.**, Box 63/6025, Margate, FL 33063. (305) 752-9202.

**TEST equipment** pre-owned now at affordable prices. Signal generators from \$50.00, oscilloscopes from \$50.00. Other equipment including manuals available. Send \$2.00 U.S. for catalog refunded on first order. **J.B. ELECTRONICS**, 3446 Dempster, Skokie, IL 60076. (708) 982-1973.

**CABLE descramblers.** Bargain headquarters. Below wholesale prices. Absolutely the lowest prices! Money back guarantee. Nobody beats us! **RP ELECTRONICS**, 1 (800) 304-3604.

**DESCRAMBLE** cable with simple circuit added to Radio Shack RF modulator and using VCR as tuner. Instructions \$10.00. **TELCOM**, Box 832-E10, Brusly, LA 70719.

**CABLE test-chips** as low as \$9.95, for testing cable boxes in full service mode. Jerrold: Starcom VI, VII & R2 V5, Jerrold cubes; Pioneer: clears E2 thru E5; Pioneer cubes: BA-5000 thru BA-6700; Tocom 5503/5507; Scientific Atlanta: 8500 thru 8600; Zenith: all but PZ1; N.E. ENGINEERING, 1 (800) 926-4030 sales, (617) 770-3830 tech, (617) 770-2305 fax. Visa, MC or COD.

**CATV Test Chips** as low as \$8.95 for testing converter boxes in full service modes. Jerrold, Tocom, Scientific Atlanta. Pioneer BA5XXX — BA67XX cubes clears E2-E5. **MICRO MAS-TERS**, 1 (800) 360-7654.

**CB Radio modifications!** Frequencies, 10M, sliders, FM, amplifiers, books, kits, repairs, high-performance accessories. The best since 1976! Catalog \$3.00. **CBCI**, Box 31500EN, Phoenix, AZ 85046.

**CABLE T.V. CONVERTERS & DESCRAMBLERS.** Replacements for most models, 30 day trial/1 year warranty. Dealers inquiries invited. Visa/MC/Disc/Amex/COD. **FOR QUALITY, PRICE & SERVICE CALL 1 (800) 259-1187, EAGLE ELECTRONICS INC.** #1, 1301 Railhead Blvd., Naples, FL 33963. No Florida sales.

**ACE personal security PRODUCTS.** Basic converters, have make and model ready. Call for free brochure 1 (800) 234-0728.

**NEW testing and descrambling equipment.** Works most cable systems. **J.V. ELECTRONICS**, (716) 342-7629 info. 1 (800) 604-8777 orders.

**ZENITH Test Chips** - activates full test mode \$24.95. Technical support with order. M-F 9-5 1 (800) 850-6566.

**STUN guns**, 200,000v \$59.95. 100,000v \$39.95 + \$5.00 S/H. Free catalog. **PERSONAL SECURITY**, Box 579361, Modesto, CA 95357-9361.

**SURVEILLANCE** Privacy security protection. Catalog \$5.00. **SPY EMPORIUM**, 6065 Hillcroft 413, Houston, TX 77081. (713) 774-1000.

## WANTED

**INVENTIONS**, ideas, new products! Presentation to industry/exhibition at national innovation exposition. Patent services. 1 (800) 288-IDEA.

## SATELLITE TV

**FREE catalog** — Lowest prices world wide. Satisfaction guarantee on everything sold — systems, upgrades, parts, all major brands factory fresh and warranted. **SKYVISION**, 1012 Frontier, Fergus Falls, MN 56537. 1 (800) 334-6455. Outside US (218) 739-5231.

**VIDEOCYpher II** descrambling manual. Schematics, video and audio. Explains DES, EPROM, CloneMaster, Pay-per-view (HBO, Cinemax, Showtime, Adult, etc.) \$16.95, \$2.00 postage. Schematics for Videocypher II Plus, \$20.00. Schematics for Videocypher II 032, \$15.00. Software to copy and alter EPROM codes, \$25.00. VCI Plus EPROM, binary and source code, \$30.00. **CABLETRONICS**, Box 30502R, Bethesda, MD 20824.

**SATELLITE TV** organizer for DOS. Two diskettes & instructions. Database software for quick changing transponders. \$19.95 plus \$3.00 S/H. **HUMANFORM ROBOTICS**, PO Box 158486, Nashville, TN 37315.

# BUY BONDS

**SINGERS! REMOVE UNLIMITED BACKGROUNDS!**

From Standard Records & CD's, with the Thompson Vocal Eliminator™ Call for Free Catalog & Demo Record.

Phone: (404) 482-4189 Ext 72  
Singer's Supply, Dept. RI-1  
7987 Hightower Trail  
Lithonia, GA 30058  
24 Hour Demo/Info Request  
Line (404) 482-2485 Ext 72  
Singer's Supply • We Have Anything & Everything For Singers




**Do-It-Yourself Electronic Kits**  
**Free Catalog Available**  
Call 213/888-8988 Fax 213/888-6868

Mark V Electronics 8019 E. Slauson Ave.,  
Montebello, CA 90640

▲ Beginner ▲ Intermediate ▲ Advanced ▲


**Stereo Loudspeaker Protector TY-26** ▲



Kit: \$ 16.75

Super fast acting relay protects speaker against destructive DC voltage. Can connect directly to a power amp, or can use a separate power supply. Has a 3 second turn-on delay to avoid turn-on thumps.


**120W MOSFET Power Mono Amp. TA-477** ▲▲



Kit: \$ 70.00

120W into 8 ohms RMS. THD: < 0.007%. Frequency Response: 8 HZ-20 KHZ, +0-0.4 dB, 2.8 HZ-65 KHZ, +0-3 dB. Sensitivity: 1V. Power Requirement: 55V DC @ 3A. May use Mark V Model # 003 or # 012 transformer.


**300W High Power Mono Amp. TA-3600** ▲▲▲



Kit: \$ 89.00

300W into 8 ohms RMS. Frequency Response: 10 HZ-20 KHZ. THD: < 0.05%. Sensitivity: 1V rms at 47K. Power Requirements: 60-75V DC at 8A. May use Mark V Model # 007 or # 009 transformer.


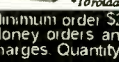
**30W+30W Pre & Main Stereo Amp. TA-323A** ▲



Kit: \$ 32.50

30W into 8 ohms RMS per channel. THD: < 0.1% from 100 HZ-10KHZ. Phono 3mV @ 47K. Tuner, Tape 130mV @ 47K. Power Requirement: 22-36V AC, 3A. May use Mark V Model # 002 transformer.

Metal Cabinets	Power Transformers
LG-1273 3X12X7" \$ 26.50	#001 28/30VX2 6A \$30.00
LG-1884 4X16X8" 32.50	#002 36VX2 3A 25.00
LG-1924 4X19X11 1/2" 38.25	#003 40VX2 6A 32.00
LG-1926 5X19X11 1/2" 42.00	#004 24VX2 6A 25.00
LG-1983 2 1/2 X 19 X 8" 35.25	#005 26VX2 3A 19.00
	#006 18VX2 5A 19.00
	#007 53VX2 8A 47.00
	#009 48/53VX2 8A 66.00
	#012 24/42VX2 8A 48.00

**Cabinet**  **Toroidal Transformer** 

Minimum order \$20.00 We accept Visa, MasterCard, Money orders and Checks. Please call for shipping charges. Quantity discounts available.

**ORDER 1-800-521-MARK/1-800-423-FIVE**

**Parts Express**



Parts Express is proud to announce that we now stock the NTE line of replacement semiconductors. NTE has been supplying the electronics industry with top notch replacement parts for over 15 years. All NTE products meet or exceed industry specifications and offer an exclusive 2 year manufacturer warranty. We also offer a complete line of parts for the service repair industry. Test equipment, loudspeakers, video and audio heads, magnetrons, belts, idler assemblies, tools, soldering equipment, just to name some of the 12,000 items we stock. Ask about our new dealer program for resellers. Call toll free for a copy of our FREE 212 page catalog. Source Code: ENM

**CALL TOLL FREE 1-800-338-0531**

Parts Express 340 E First St, Dayton, Ohio 45402-1257  
Phone: 513-222-0173 Fax: 513-222-4644



Call for your  
**FREE** catalog!

# Your One Stop Component & Computer Source

Special Prices for  
Electronics Now  
Readers. Please  
mention VIP #OR5!

## Electronic Kits

### Universal Mono Pre-amplifier

- Requires power supply: 10-30 VDC/10 mA (P/N 20626)
- Output impedance: 1 Kohm
- Adjustable output level
- Frequency range: 20 Hz to 20 KHz +/-3dB
- Max. input signal: 40 mV
- PCB dimensions: 1.76"L x 1.2"W x 0.8"H
- Weight: 0.31 lbs.

Part No.	Description	1-4	5-9
117612	Pre-amplifier	\$9.95	\$8.95

### FM Oscillator

- Mini FM transmitter (100-108 MHz) is ideal for family broadcasts, baby monitor, security. May be received by any portable FM radio or tuner.
- Integrated pre-amplifier (sensitivity 5 mV)
  - Requires power supply: 9-12 VDC (P/N 20626 or equivalent)
  - PCB dimensions: 2.8"L x 1.8"W x 1.1"H
  - Weight: 0.33 lbs.

Part No.	Description	1-4	5-9
117604	FM Oscillator	\$12.95	\$11.49

### 1 Amp Power Supply

- Provides a regulated voltage adjustable between 1.2 and 35 Volts at 1 Amp. LM317 regulator gives you remarkably better ripple and regulation characteristics than conventional regulators.

- Output current max.: 1.5A
- Requires Power transformer 25.2 VCT @ 2A (P/N 102103 or equivalent)
- Max. dissipation: 15 W (cooled)
- Max. input voltage: 40 V
- PCB dimensions: 2.08"L x 2.08"W x 2.0"H
- Weight: 0.34 lbs.

Part No.	Description	1-4	5-9
117621	Power supply	\$12.95	\$11.49

### Stroboscope

- Flash frequency adjustable from 2 to 20 Hz
- Input: 110VAC
- Weight: 0.23 lbs.
- PCB dimensions: 3.48"L x 2.6"W x 2.3"H

Part No.	Description	1-4	5-9
117639	Stroboscope	\$19.95	\$17.95

### Wireless Remote Control

- Over 8000 codes
  - Use several transmitters with one receiver
  - Receiver/transmitter range: 100 ft.
- 117647:**
- 2 channel transmitter
  - Key ring housing
  - Power supply: 12V battery type V23GA
  - Wt.: 0.36 lbs.
- 117655:**
- 1 channel receiver
  - Relay output 10A toggle or pulse contact
  - LED indicator • Separate output to switch car alarm on or off
  - Power supply: 18 VCT transformer (P/N 105531) or Power Source
  - PCB dimensions: 3.64"L x 3.04"W x 1.0"H
  - Weight: 0.49 lbs.

Part No.	Description	1-4	5-9
117647	Transmitter	\$29.95	\$26.95
117655	Receiver	\$39.95	\$35.95

### Laser Pointer Kit

Well-suited to engineers, presenters, teachers, lecturers and executives.

- Light weight
- Ergonomically designed
- Easy to assemble
- Some soldering required
- Size: 4.5"L x 0.2"W x 0.6"H

Part No.	Description	1-9	10-24
121339	Laser pointer kit	\$39.95	\$35.95

### Laser Diode Module

- Operates on 3VDC @ <5mW
- Has a built in lens
- 670nm wavelength
- 1" color coded, tinned leads
- Size: 0.9"L x 0.4"D

Part No.	Description	1-4	5-9
123043	Laser diode module	\$47.95	

### Jameco Analog Display Soldering Station

- Electronic temperature control
- Zero-Voltage thyristor switching protects voltage and current sensitive devices
- Power-on and Heater-on LED indicators
- Power consumption: 60 watts • UL listed
- Includes one 35115, 1/16" tip
- Size: 4.3"W x 6"D x 3.4"H • Weight: 4.2 lbs.

Part No.	Description	1-4	5-9
114569	Analog Station	\$79.95	

### Linear Integrated Circuits

Part No.	Product No.	1-9	10-99
23051	LH002CN	\$8.95	\$7.95
27852	OP07	SALE 1.75	1.75
24811	MAX232CPE	1.95	1.75
23579	LM317T	.69	.59
23683	LM324N	.39	.35
23721	LM331N	3.95	3.49
23771	LM336Z	.79	.69
23851	LM339N	.45	.39
23966	LM358N	.45	.39
24061	LM381N	6.95	6.25
24109	LM385Z	1.19	1.09
24117	LM385Z1.2	1.19	1.09
24133	LM386N-3	.89	.79
24301	LM399H	5.95	5.35
27422	NE555V	.35	.29
24328	LM556N	.49	.45
24352	LM565N	1.49	1.29
24539	LM741CN	.35	.29
23157	LM1488N	.45	.39
23181	LM1489N	.45	.39
34972	XR2206	3.49	3.19
39600	26LS32	SALE .79	.79
23341	LM2917N-14	1.49	1.29
24230	LM3914N	2.09	1.95
27385	NE5532	.89	.79
51182	78L05	.29	.25
51246	7805K	SALE 1.69	1.69
51262	7805T	.45	.39
51334	7812T	SALE .39	.39
25064	MC14490P	4.25	3.95
50964	75176	1.49	1.29
25099	MC145406P	1.95	1.75

### 3 1/2 Digit Pocket Multimeter

- Measures: AC/DC voltage, DC current, HFE and resistance
- DC Voltage: 200mV, 2V, 20V, 200V, 1000V
- AC Voltage: 200V, 750V
- Resistance: 200 $\Omega$ , 2 K $\Omega$ , 20 K $\Omega$ , 200 K $\Omega$ , 2M
- DC Current: 200 mA, 2mA, 20mA, 200mA, 10A
- Diode Test • Transistor HFE
- Removable test leads
- Size: 2.62"W x 1"D x 4.75"H
- Weight: 0.5 lbs. • One-year warranty

Part No.	Description	1-9	10-24
119212	Digital multimeter	\$19.95	\$17.95

### Jameco Digital Lab

- Includes:
- Solderless Breadboard
  - DC Power Supplies
  - Two 7-Segment Displays
  - Function Generator (5 ranges)
  - Digital Voltmeter (DVM) 4 ranges
  - Size: 10.625"W x 13.25"D x 5"H
  - One-year warranty • Weight: 8.5 lbs.

Part No.	Description	1-4	5-9
75838	Digital Lab	\$299.95	\$279.95

### Jameco Solderless Breadboards

- Our long-lasting breadboards feature screen printed color coordinates and are suitable for many kinds of prototyping and circuit design.
- Larger models feature heavy-duty aluminum backing with voltage and grounding posts.
- One-year warranty

Part No.	Terminal Strips	Bus Strips	Contact Points	1-9	10-49
20343	0	2	200	\$2.95	\$2.59
20600	1	2	400	4.95	4.49
20669	1	0	630	4.95	4.49
20722	1	2	830	6.95	6.25
20757	2	1	1,360	12.95	11.49
20773	2	4	1,660	16.95	14.95
20790	3	5	2,390	22.95	19.95
20811	4	7	3,220	29.95	27.95

### Jameco Wire Jumper Kit

- 25 each of lengths 0.1 through 5.0 (14 sizes)
- 350 assorted lengths in 13 colors
- Pre-stripped/pre-formed
- 22 AWG solid wire jumpers
- Handy, durable, clear plastic case

Part No.	Description	1-9	10-49
19289	Wire jumper kit	\$9.95	\$8.95
20079	Refill for 19289	7.95	6.95

### 486SLC2 66MHz Bare-bones System

- Includes motherboard, computer case, & power supply
- IBM 486SLC2 66MHz CPU
  - AMi BIOS
  - 64KB cache memory (up to 128KB)
  - Memory expandable to 16MB using (70ns) SIMMs • (7) 16-bit w/ (2) 32-bit (VESA local bus) slot extensions & (1) 8-bit slot

Part No.	Description	1-4	5-9
121208	486SLC2 66MHz	\$279.95	\$259.95

### 14" Paper White Monochrome Monitor & Adapter

- 0.31mm dot pitch
- Supports MDA, Hercules graphics (HGC)
- 720 x 348 • Tilt/swivel base
- Input: DB9-pin (TTL) connector

Part No.	Description	1-4	5-9
119482	White monitor	\$109.95	\$99.95
19684	Adapter	SALE 14.95	

### Jameco 101-Key Enhanced Keyboard

- PC/XT/AT/386/486 compatible
- LED indicators for Num Lock, Caps Lock and Scroll Lock
- 12 function keys with separate cursor and numeric keys • 90-day warranty
- Size: 19"L x 8"W x 1.3"H • Weight: 5 lbs.

Part No.	Description	Special Price
67432	101-key keyboard	\$19.95

### GoldStar Precision Oscilloscopes

- Cursor readout
- 6" rectangular CRT with internal graticule & scale
- One-year warranty
- Bandwidth:** DC to 20MHz (P/N 124011) DC to 40MHz (P/N 66051)
- Time Base:** Time Base A: 0.2 $\mu$ s/div to 0.2s/div in 19 calibrated steps, 1-2-5 sequence. Uncalibrated continuous control between steps at least 1:2.5

- Hold-Off Time: variable with the hold-off control
- Time Base B: 0.2 $\mu$ s/div to 20 $\mu$ s/div in 7 calibrated steps 1-2-5 sequence
- Cursor Readout Function:** Voltage reference  $\Delta$ V,  $\Delta$ -REF/Time reference  $\Delta$ T,  $\Delta$ -REF/Frequency reference 1/ $\Delta$ T,  $\Delta$ -REF/Note:  $\Delta$ V,  $\Delta$ T changed:  $\Delta$ X  $\Delta$ T when the X-Y mode
- Signal Delay: Delay cable supplied (P/N 66051)

Part No.	Description	1-4	5-9
124011	120MHz w/readout	SALE \$649.95	
66051	40MHz w/readout	SALE 749.95	

### 51 Piece Tool Kit

- An assortment of the most essential tools for maintenance and repair jobs. Black vinyl-covered case features removable pallets, a combination lock and a cushioned, black plastic handle.
- Weight: 11 lbs. • Size: 12.5"L x 17.5"W x 3.5"H

Part No.	Description	Special Price
26681	51 Piece tool kit	\$99.95

### Skynet 42.6 Watt Switching Power Supply

- Output: 5V @ 3A, 12V @ 2A, -12V @ 3A
- Input: 115/230VAC • Input jumper selectable
- UL/CSA approved
- Size: 5"L x 3"W x 2"H

Part No.	Product No.	Special Price
124177	SNP8171	\$9.95



1355 Shoreway Road Call for your FREE catalog

Belmont, CA 94002-4100

FAX: 1-800-237-6948 (Domestic)

FAX: 415-592-2503 (International)

New Hours: 6AM - 6PM PST

© 1995 Jameco 10/95

No Minimum Order  
Call for Details



**Call 1-800-831-4242 to order today!**

# ALL ELECTRONICS

FAST SERVICE • DISCOUNT PRICES

Visit Our **INTERNET Site**

<http://www.allcorp.com/allcorp/>

## S.P.D.T MOMENTARY PUSH PUTTON



### SPECIAL PRICE!

Alcoswitch # MPS103D-R  
S.P.D.T. miniature pushbutton switch.  
Push-on / Push-off, snap-action switch.  
Unthreaded, 0.24" dia. X 0.33" long bushing.  
Green 0.4" dia. cap. Right-angle pins for PC  
board mounting.  
Contacts rated  
3 amps @ 115 Vac.

**\$1.00**  
each

CAT# MPB-22

25 for \$22.50

## 12 Vdc 2.3 A/h (Used) GELL CELL BATTERY

7" X 2.37" X 1.35"  
Used, but  
guaranteed  
functional sealed  
gel cell batteries.



CAT# GC-123U

**\$6.00**  
each

## SMALL STEPPING MOTOR

Airpax # NB82115-M3  
12 Vdc, 65 ohm  
stepper motor with  
6 leads. 15 degree  
step angle. 1" diameter x 0.5"  
high. Mounting flange with holes on 1.25"  
centers. 0.08" (2mm) dia. X 0.2" long shaft.  
0.27" diameter pulley is press-it onto shaft.  
Great for robotics  
and experimentation.



**\$1.50**  
each

CAT# SMT-13

10 for \$12.50

## 9' DUAL AUDIO CABLE



9' shielded dual audio cable with color coded  
(red and yellow) RCA style pin  
plugs either end. Black cable.

**\$1.00**  
each

CAT# DCB-108

10 for \$8.50 • 100 for \$75.00  
1000 for \$500.00

**LARGE  
QUANTITY  
AVAILABLE!**

ORDER TOLL FREE

**1-800-826-5432**

CHARGE ORDERS to Visa, Mastercard or Discover

TERMS: NO MINIMUM ORDER. Shipping and handling for the  
48 continental U.S.A. \$5.00 per order. All others including AK,  
HI, PR or Canada must pay full shipping. All orders delivered in  
CALIFORNIA must include local state sales tax. Quantities  
Limited. NO COD. Prices subject to  
change without notice.

CALL, WRITE,  
FAX or E-MAIL  
for a FREE  
64 Page  
CATALOG

Outside the U.S.A.  
send \$2.00 postage.

MAIL ORDERS TO:  
**ALL ELECTRONICS  
CORPORATION**  
P.O. Box 567  
Van Nuys, CA 91408  
FAX (818)781-2653

E-mail [allcorp@allcorp.com](mailto:allcorp@allcorp.com)

CIRCLE 107 ON FREE INFORMATION CARD

## ADVERTISING INDEX

Electronics Now does not assume any  
responsibility for errors that may appear  
in the index below.

Free Information Number	Page
107	All Electronics . . . . . 98
109	C&S Sales . . . . . 1
187	Cable Warehouse . . . . . 22
—	CLAGGK . . . . . 78
—	Cleveland Institute of Elec. . . . . 21
—	Command Productions . . . . . 15
—	Electronics Tech. Today . . CV3, 13
121	Fluke Corporation . . . . . CV2
184	Foley-Belsaw Company . . . . . 23
—	Grantham College . . . . . 27
—	Information Unlimited . . . . . 23
126	Interactive Image Technologies . . 7
—	Jameco . . . . . 97
179	LG Precision . . . . . 12
93	Mark V Electronics . . . . . 96
186	Mini-Circuits . . . . . CV4
117	Mouser Electronics . . . . . 15
182	National Electronic Wholesalers 22
—	NRI Schools . . . . . 11, 39
56	Parts Express Inc. . . . . 96
185	Protek . . . . . 17
—	Tab Books . . . . . 5, 56
—	Tektronix, Inc. . . . . 24
—	Tektronix, Inc. . . . . 74A & B
—	World College . . . . . 31

**Gernsback Publications, Inc.**  
500 Bi-County Blvd.  
Farmingdale, NY 11735-3931  
1-(516) 293-3000  
Larry Steckler, EHF/CET  
President

**Christina Estrada**  
assistant to the President

**For Advertising ONLY**  
1-516-293-3000  
Fax 1-516-293-3115

**Larry Steckler**  
publisher

**Arline Fishman**  
advertising director

**Denise Mullen**  
advertising assistant

**Adria Coren**  
credit manager

**Subscriber Customer Service**  
1-800-288-0652

**Order Entry for New Subscribers**  
1-800-999-7139  
7:00 AM - 6:00 PM M-F MST

## ADVERTISING SALES OFFICES

### EAST/SOUTHEAST

**Stanley Levitan**  
Eastern Advertising  
1 Overlook Ave.  
Great Neck, NY 11021-3750  
1-516-487-9357  
Fax 1-516-487-8402

### MIDWEST/Texas/Arkansas/Okla.

**Ralph Bergen**  
Midwest Advertising  
One Northfield Plaza, Suite 300  
Northfield, IL 60093-1214  
1-708-446-1444  
Fax 1-708-559-0562

### PACIFIC COAST

**Blake Murphy**  
Pacific Advertising  
Hutch Looney & Associates, Inc.  
6310 San Vicente Blvd.  
Suite 360  
Los Angeles, CA 90048-5426  
1-213-931-3444  
Fax 1-213-931-7309

### Electronic Shopper

**Joe Shere**  
National Representative  
P.O. Box 169  
Idyllwild, CA 92549-0169  
1-909-659-9743  
Fax 1-909-659-2469



**Plug a Friend into**  
**Electronics**  
**NOW**  
**and Save \$26.03\***

*This Christmas give an electrifying gift ... plug a friend into Electronics Now and brighten the whole new year! Whether electronics is your friend's livelihood or hobby, your gift will illuminate the whole spectrum of electronics throughout the coming year and provide a monthly reminder of your friendship.*

Electronics Now will keep your friend informed and up-to-date with new ideas and innovations in all areas of electronics technology ... computers, video, radio, stereo, solid state devices, satellite TV, industrial and medical electronics, communications, robotics, and much, much more.

We'll provide great plans and printed circuit patterns for great electronic projects. In just the last year, Electronics Now has presented amateur TV equipment, computer peripherals, microcontroller programmers, test equipment, audio amplifiers, telephone projects, relay circuits and much more.

PLUS ... equipment troubleshooting techniques ... circuit design ... reports on new technology and products ... equipment test reports ... in-depth coverage on computers, video, audio, vintage radio ... and lots more exciting features and articles.

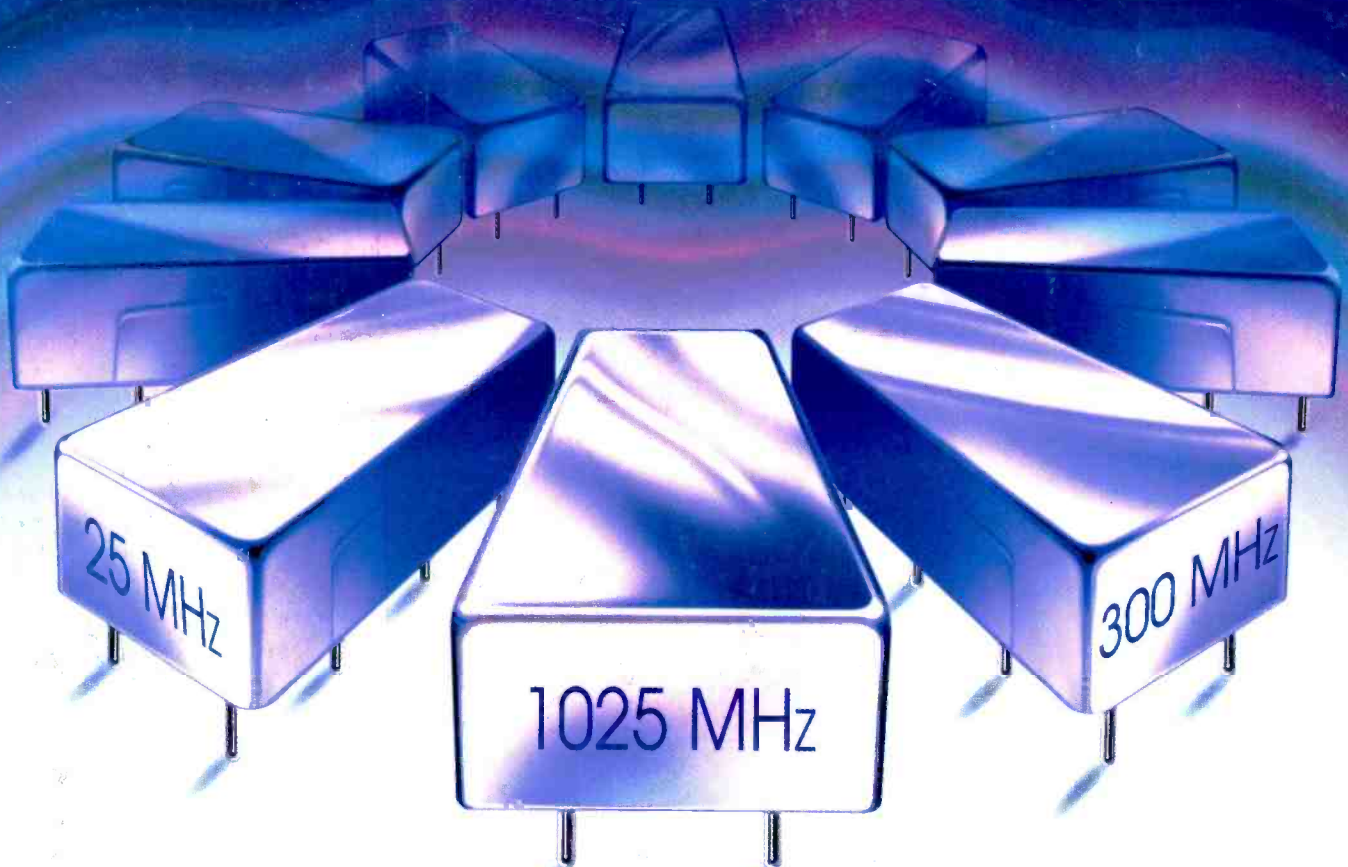
SAVE \$26.03\* ... OR EVEN \$52.06\* ... For each gift of Electronics Now you give this Christmas, you save a full \$26.03\* off the newsstand price. And as a gift donor, you're entitled to start or extend your own subscription at the same Special Holiday Gift Rate—you save an additional \$26.03\*!

No need to send money ... if you prefer, we'll hold the bill till January, 1996. But you must rush the attached Gift Certificate to us to allow time to process your order and send a handsome gift announcement card, signed with your name, in time for Christmas.

So do it now ... take just a moment to fill in the names of a friend or two and mail the Gift Certificate to us in its attached, postage-paid reply envelope. That's all it takes to plug your friends into a whole year of exciting projects and new ideas in Electronics Now!

\*Basic sub rate — 1 yr/\$19.97 2 yrs/\$38.97

# VOLTAGE CONTROLLED OSCILLATORS



**25 to 1025MHz (+7dBm output) From \$11<sup>95</sup>** (5-49)

It's a fact! With Mini-Circuits new POS family of shielded, laser sealed voltage controlled oscillators, you pay less but get more... top notch quality, superior performance and value pricing.

Features include wide-band models with near octave bandwidth and linear tuning. Low SSB phase noise characterized at 100Hz to 1MHz offsets. Excellent harmonic suppression, typically more than 25dB. RF power output typically +7dBm, excellent for driving level 7 mixers. Miniature size, only 0.4 X 0.8 inch board space. Hermetically sealed and ruggedly constructed for tough environments. Best of all, Mini-Circuits high performance, highly reliable VCO's can be yours at value prices starting at only \$11.95 each (qty.5-49). To order from stock, call Mini-Circuits today.

**Mini-Circuits...we're redefining what VALUE is all about!**

#### DESIGNER'S KITS:

K-POS1 \$124.95 (contains 1ea. all models).

K-POS2 \$79.95(contains 1ea. all models except POS-75,-150,-300).

Model No.	Freq. Range (MHz) Min.	Phase Noise (dBc/Hz) SSB @10kHz Typ.	Harmonics (dBc) Typ.	Power 12V DC Current mA	Price (Qty.5-49) \$ ea.
POS-50	25-50	-110	-19	17	11.95
POS-75	37.5-75	-110	-27	17	11.95
POS-100	50-100	-107	-23	18	11.95
POS-150	75-150	-103	-23	18	11.95
POS-200	100-200	-102	-24	18	11.95
POS-300	150-280	-100	-30	18	13.95
POS-400	200-380	-98	-28	18	13.95
POS-535	300-525	-93	-26	18	13.95
POS-765	485-765	-85	-21	22	14.95
POS-1025	685-1025	-84	-23	22	16.95

Notes: Tuning voltage 1 to 16V required to cover freq. range.  
Operating temperature range: -55°C to +85°C.

## Mini-Circuits®

P.O. Box 350166, Brooklyn, New York 11235-0003 (718) 934-4500 Fax (718)332-4661

For detailed specs on all Mini-Circuits products refer to • THOMAS REGISTER • MICROWAVE PRODUCT DATA DIRECTORY • EEM • MINI-CIRCUITS' 740- pg. HANDBOOK.

**CUSTOM PRODUCT NEEDS...Let Our Experience Work For You.**

F 195 Rev A

CIRCLE 186 ON FREE INFORMATION CARD  
www.americanradiohistory.com